

YAESU

FT-757GX II
OPERATING
MANUAL

Scanned by MitchMade

YAESU MUSEN CO., LTD

C.P.O. BOX 1500
TOKYO, JAPAN

TABLE OF CONTENTS

| | (Page) |
|--|--------|
| GENERAL DESCRIPTION | 1 |
| SPECIFICATIONS | 3 |
| FRONT PANEL CONTROLS | 5 |
| REAR PANEL CONTROLS & CONNECTORS | 8 |
| TOP COVER (KEYING) CONTROLS | 10 |
| INSTALLATION | 11 |
| INTERCONNECTIONS | 14 |
| MICROPHONES | 17 |
| PLUG CONNECTIONS | 17 |
| OPERATION | 18 |

IMPORTANT NOTICE!!

When shipped from the factory, the LIN AMP and MARKER buttons on the rear panel were both set to the depressed position, to clear the memory data. One or both of these must be set to the undepressed position to activate the internal memory backup system.

Also, before connecting power to the transceiver, make sure that the MOX button and the POWER button on the front panel are in the undepressed position, and that the PTT switch on your microphone is not closed. Otherwise, when power is switched on the transceiver will not function, since it cannot be switched on while in the transmit mode.

FT-757GX II HF ALL MODE COMPUTER AIDED TRANSCEIVER



GENERAL DESCRIPTION

The FT-757GXII combines the finest features of its famous predecessor, the FT-757GX, with new developments in response to technological advances and to the most popular requests from serious hf operators. New advances in digital control and computer-aided manufacturing methods allow the FT-757GXII to offer great versatility and operator convenience on all modes and all hf amateur radio bands, with 100 watts of PEP transmitter power output on the amateur bands, and general coverage reception from 0.15 to 30 MHz.

Special new digital features include operator selectable mode-dependent tuning steps, ten memory channels which store mode as well as frequency, auto-resume loop scanning between dual VFOs (or adjacent memories), a special clarifier memory, and an improved CAT (Computer Aided Transceiver) System for simplified programming and more advanced control by an external computer.

A 40dB IF Notch filter is provided along with continuously adjustable IF Shift for minimizing interference during SSB, CW and ECSS reception of AM signals. Wideband AM and narrowband CW IF filters are included as standard. A switchable RF amplifier and 20dB attenuator are provided to optimize sensitivity and dynamic range on all frequencies under a wide variety of conditions, while the noise blanking pulse width can be set on the front panel, continuously adjustable from narrow (ignition-type) to wide ("woodpecker") blanking pulse widths.

Full break-in QSK CW operation is provided with Yaesu's custom-designed electronic keyer built in, as a standard feature. New high voltage solid state transmit/receive switching circuitry is provided for direct t/r control of a wide variety of QSK and non-QSK linear amplifiers.

SSB and AM signal punch can be increased by the AF speech processor, which combines clipping and compression circuitry to optimize average speech power with minimum distortion. Careful filtering before modulation assures clean output with a substantial increase in average power. The diecast top half of the FT-757GXII serves as the heatsink for the final power amplifier, and forced-air cooling through the chassis allows full power FM and AFSK operation when used with a heavy duty power supply.

Optional accessories include your choice of the MD-1B8 Desktop Scanning Microphone or the MH-1B8 Handy Scanning Microphone, and the microprocessor controlled FC-757AT 100-watt Automatic Antenna Tuner or FL-7000 500-watt Automatic Solid State QSK Linear Amplifier, each of which automatically selects and tunes up to five antennas when used with the FAS-1-4R Remote Antenna Selector.

Power supplies for the FT-757GXII include the FP-757HD Heavy Duty Series-Regulator Power Supply with forced-air cooling and automatic thermal fan control, or the light-duty FP-700 standard supply, ideal when the transceiver is used as an exciter for the FL-7000, or for low power and light-duty applications. All power supplies can be wired for 100/110/117/200/220 or 234 VAC.

FT-757GXII Duct Flow Cooling System

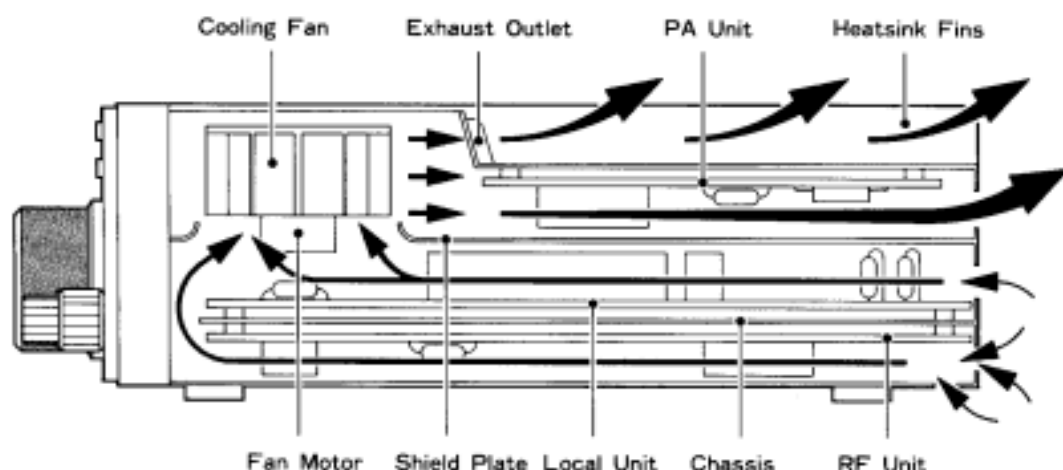

SPECIFICATIONS

TRANSMITTER

Frequency range

| | |
|-----------|----------------------|
| 160m band | 1.5 to 1.99999 MHz |
| 80m band | 3.5 to 3.99999 MHz |
| 40m band | 7.0 to 7.49999 MHz |
| 30m band | 10.0 to 10.49999 MHz |
| 20m band | 14.0 to 14.49999 MHz |
| 17m band | 18.0 to 18.49999 MHz |
| 15m band | 21.0 to 21.49999 MHz |
| 12m band | 24.5 to 24.99999 MHz |
| 10m band | 28.0 to 29.99999 MHz |

Tuning steps (selectable)

| | |
|-----------|------------------------|
| SSB & CW: | 10 Hz or 1 kHz/step |
| AM: | 1 kHz or 10 kHz/step |
| FM: | 2.5 kHz or 10 kHz/step |

Emission types

LSB, USB (J3E); CW (A1A); AM (A3E)
and FM (G3E)

Power output

SSB, CW & FM: 100W PEP/DC, with
slightly less on 10m band
AM: 25W Carrier

SSB Carrier suppression

better than 40dB below peak output

Unwanted sideband suppression (SSB)

better than 50dB below peak output
(1 kHz tone)

Spurious radiation

better than 50dB below peak output

Audio response

less than -6dB from 350 to 2900Hz

3rd order intermodulation distortion

better than -35dB below peak output
(@14 MHz, 100W)

Reference oscillator stability

better than ± 10 ppm from 0 to 40°C
after 15 minute warmup

Modulation systems

SSB/CW: active balanced modulator
AM: early stage (low level)
FM: variable reactance

Maximum FM deviation

± 5 kHz

RF Output impedance (nominal)

50 ohms, unbalanced

Microphone impedance

500 to 600 ohms

RECEIVER

Frequency range

150 kHz to 29.99999 MHz (continuous)

Circuit type

Triple-conversion superheterodyne

Clarifier range

unlimited (full receiver range)

Sensitivity (for 10dB S+N/N, exc FM)

| | 150-250kHz | 250-500kHz | above 500kHz |
|--------|-------------------------------------|------------|--------------|
| SSB/CW | 1.0uV | 0.5uV | 0.25uV |
| AM | 10uV | 4uV | 1uV |
| FM: | 0.5uV for 12dB SINAD (above 500kHz) | | |

Intermediate frequencies

47.060MHz, 8.215MHz, 455kHz

Image rejection

better than 70dB

IF rejection

better than 70dB (all frequencies)

Selectivity (-6/-60dB)

| | |
|------------------|----------------|
| SSB, CW(W) & FSK | 2.7/4.5 kHz |
| CW(N) | 600 Hz/1.3 kHz |
| AM | 6/18 kHz |
| FM | 15/30 kHz |

Dynamic range (CW(N) @14 MHz)

better than 100dB

Maximum audio power output

at least 1.5W into 4 ohms w/10% THD

Audio output impedance

4 to 16 ohms

GENERAL

Supply voltage
13.5 VDC \pm 10%

Power consumption
Receiver: 2A
Transmitter (100W output) 19A

Dimensions (WHD)
238 x 93 x 238mm (without feet or knobs)

Weight (approx)
5.2 kg (11.5 lb)

Specifications may be subject to change without notice or obligation.

ACCESSORIES

Supplied

| | | Part No. |
|-------------------|-----------------|----------|
| DC Power Cord | (w/o fuse) | T9014900 |
| Fuses | (2 supplied) | |
| FT-757GXII | (20A) | Q0000009 |
| FT-757SXII | (6A) | Q0000012 |
| 3-pin Phone plug | (SH3603) | P0090008 |
| RCA (phono) plugs | (STP-58, 2 pcs) | P0090018 |

Options

| Model | | Part No. |
|------------------------------|--|----------|
| MD-1B8 | Desktop Scanning Microphone | D1000039 |
| MH-1B8 | Hand Scanning Microphone | D1000040 |
| FRB-757 | Relay Control Box | D3000280 |
| MMB-20 | Mobile Mounting Bracket | D6000032 |
| External Computer Interfaces | | |
| FIF-65A | for Apple II | |
| FIF-232C | for RS-232C | |
| FP-757HD | Heavy Duty Power Supply | |
| FP-700 | Standard Duty Power Supply | |
| FC-757AT | Automatic Antenna Tuner (100W) | |
| FL-7000 | 500W QSK Automatic Linear Amplifier | |
| FAS-1-4R | Remote Antenna Selector (1.2kW, for use with FC-757AT or FL-7000) | |
| SP-767 | Base Station Loudspeaker | |
| SP-767P | Base Loudspeaker w/Phone Patch | |
| SP-55 | Mobile Loudspeaker | |
| E-757III(CAT-N) | Connection Cable (to FIF-232C) | |

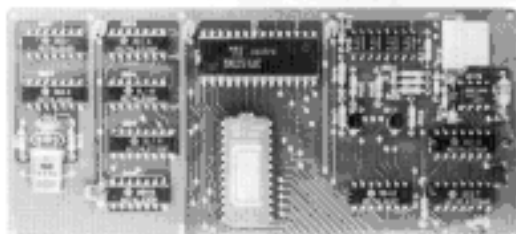

FIF-65A



FL-7000



FIF-232C



SP-767P



FC-757AT

FRONT PANEL CONTROLS

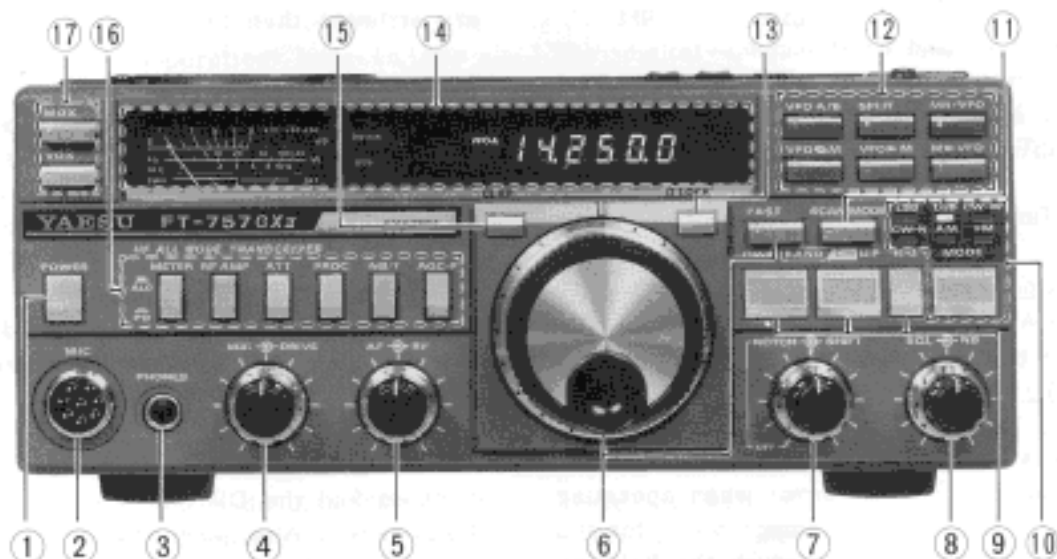

(1) POWER

This pushbutton switch turns the transceiver on and off. Frequency and mode data stored in the memories and vfos is not affected by this switch, or by whether power is connected to the transceiver, since this data is retained by an internal lithium battery while the backup system is activated.

(2) MICROPHONE

This 8-pin connector accepts the plug of the MD-1B8 Desktop Mic or MH-1B8 Hand Mic. Scanning control lines from these microphones allow pushbutton fast and slow tuning from the microphone (duplicating the functions of the tuning knob and FAST button). See page 17 for pinout.

(3) PHONES

Monaural or stereo headphones with 4-16 ohms impedance may be connected to this jack. Stereo headphones with a 3-conductor plug will reproduce the audio in both ears, as with monaural headphones with a 2-conductor plug. Inserting a plug into this jack disables the internal or external loudspeaker.

(4) MIC/DRIVE

The inner MICROPHONE control adjusts the gain of the transmit audio amplifier used during SSB and AM transmission (for FM, gain is preset internally). This control adjusts output power in SSB modes when the speech processor is off, and modulation level in the AM mode. It is disabled when the processor is on, and during FM and CW transmission.

The outer DRIVE control adjusts the carrier power output level for CW, AM and FM transmission. This control is disabled during SSB transmission.

(5) AF/RF

The inner AF control adjusts receiver volume.

The outer RF control adjusts the gain of the receiver RF and IF amplifiers via the agc line. This control is normally set fully clockwise for peak receiver sensitivity. When it is set counterclockwise from maximum, the S-meter minimum deflection point will be moved up the scale, and weaker signals (or noise)

will be suppressed, although S-meter deflection for stronger signals will remain the same. This control also affects the squelch threshold, and so should be set before the SQL (squelch) control.

(6) Tuning Knob and FAST button

This knob tunes the transceiver at a rate determined by the operating mode and selected by the FAST button:

Tuning Rates in kHz/step

| MODE | FAST ON | FAST OFF |
|--------|---------|----------|
| SSB/CW | 1 kHz | 10 Hz |
| AM | 10 kHz | 1 kHz |
| FM | 10 kHz | 2.5 kHz |

This knob is disabled when the LOCK button is pressed, during transmission or when operating on a memory. A torque adjustment screw for the tuning knob is accessible through the hole on the bottom of the transceiver, just beneath the knob (see page 16).

(7) NOTCH/SHIFT

The inner NOTCH control activates the IF notch filter when turned clockwise out of the click stop, and tunes the notch across the IF passband. Its setting is independent of the operating frequency and IF Shift setting. Set this control into the click stop (off) when the notch filter is not needed. The notch filter is disabled in the FM mode.

The outer SHIFT control sets the position of the receiver IF passband relative to the receiving frequency in SSB, CW and AM modes, to suppress interference on nearby channels. At the 12 o'clock position the IF passband is centered on the (displayed) receiving frequency; turn this control counterclockwise to lower the IF passband, or clockwise to raise the passband. When no interference is present, set this control to the 12 o'clock position.

(8) SQL/NB (Squelch/Noise Blanker)

The inner squelch control is used to set the threshold level of incoming signals or noise at which receiver audio is muted. This threshold point also serves as the scan stop setting when scanning. Clockwise rotation increases the threshold level, causing the receiver not to respond to background noise or weaker signals.

The outer noise blanker control adjusts the decay time of the noise blanker agc, which determines the width of the blanking pulse when the noise blanker is activated during SSB and CW reception (and AM when the noise pulses are stronger than the received carrier).

(9) BAND/CH (DWN & UP keys) and H/G button
During reception with a vfo, the two large DWN and UP keys are used to change frequency bands, and for 500 kHz steps. The H/G (Ham/General coverage band step selector) button determines whether the DWN & UP keys step through the amateur bands only, or in 500 kHz general coverage steps. A beep sounds when any of these are pressed. See the Operation section of this manual for details.

When receiving on a memory the H/G button is disabled and the DWN & UP keys step through the memories. Also, when the SCAN MODE switch is pressed, the DWN & UP keys activate and deactivate PMS scanning between memories.

(10) MODE Select Button and Indicators

Press this button to select the operating mode while receiving (a beep will sound). The selected mode is indicated by one of the six LED indicators.

(11) SCAN MODE Pushbutton Switch

Press this 2-position switch to select scanning facilities. While depressed, the functions of the DWN & UP keys and the VFO and Memory keys are altered (from the basic functions described in this section) to select and control various scanning functions, as described in the Operation section.

(12) VFO and Memory Keys

These six keys transfer frequency and mode data between the vfos and memories. A beep sounds when one is pressed. As they function during transmit as well as receive, use care to avoid accidental changes while transmitting. Two keys have yellow markings to indicate that data will be overwritten when they are pressed. Some of these keys also take on special functions when the SCAN MODE switch is depressed. These are described later.

VFO A/B

This key exchanges the contents of the two vfos (called A and B).

SPLIT

Press this key to activate split-frequency operation between the two vfos, and press it again to cancel split operation.

MR/VFO

This key switches operation between the last-used vfo and the last-used memory. The frequency and mode data in the vfo and memory are unaffected. The display indicates which (vfo or memory) is currently selected.

VFO \square M

This key exchanges the frequency and mode contents of the last-used vfo and the last-used memory.

VFO \blacktriangleright M

Press this key when operating on a vfo to store the frequency and mode data from that vfo into the last-used memory. This will overwrite previous memory data, and leave the vfo and memory the same. This key is disabled when operating on a memory.

M \blacktriangleright VFO

Press this key when operating on a memory to transfer its data into the last-used vfo. This will overwrite previous vfo data, leaving the vfo and memory the same. After pressing this key operation will be on the vfo.

(13) DLOCK

This button disables the tuning knob to prevent accidental frequency changes. "LOCK" is shown on the display when active. Press this button again to re-enable tuning.

(14) Meter & Display

The meter shows relative signal strength in S-units on the uppermost scale when receiving, and either relative power output (PO), transmitter automatic level control (ALC) or reflected power output (SWR) during transmission. The METER button on the front panel and the FWD-REV switch on the rear panel select the meter function for transmission.

To the right of the meter the ON AIR indicator glows red when transmitting, and the GEN indicator glows green when general coverage band stepping is selected (via the H/G button).

At the left side of the operating frequency, the display tube includes the following indicators:

LOCK - tuning knob locked

SPLT - split frequency operation active

CLAR - clarifier active

VFO A - operating vfo, or

VFO B - or

MR - operation is on a memory

The digital frequency display indicates the operating frequency with 100 Hz resolution. When operating on a memory, the memory channel number (0 thru 9) is displayed with 'CH' to the right of the frequency.

(15) CLAR

Press this button while receiving on a vfo to activate clarifier operation. The tuning knob and DWN & UP keys can then be used to tune the receiver without affecting the transmit frequency. Press this button again to cancel the change in receiver frequency and return to where you were. The clarifier is disabled when receiving on a memory.

(16) Pushbutton Switches

Each of these switches has two positions; when depressed the labelled function is on, and when undepressed the labelled function is off, except for the METER switch described next.

METER selects either ALC or power output functions of the meter during transmission. Power output functions (forward, or reverse) are in turn selected by the FWD-REV switch on the rear panel. ALC is indicated when this switch is in the depressed position, and power output when it is undepressed.

RF AMP activates the rf amplifier in the receiver front end when depressed, for maximum receiver gain. In the undepressed position the RF amplifier is bypassed, for increased immunity to overload from strong signals on other frequencies.

ATT places a 20dB attenuator in the receiver front end circuit, to reduce sensitivity and avoid overload of the rf amplifier and mixer when listening to very strong signals.

PROC activates the AF speech processor to increase average speech power during SSB transmission, according to the level set by the COMP LEVEL control on the rear panel.

NB/T activates the noise blanker for SSB, CW and AM reception. The NB control at the lower right corner can then be used to set the blanking pulse width.

AGC-F activates fast agc decay time for SSB, CW and AM reception, to facilitate scanning and tuning or listening to very weak signals. When not depressed, slow agc decay is provided for more comfortable reception of strong signals.

(17) MOX and VOX Pushbutton Switches

The transmitter can be manually switched on and off by the MOX switch. This is useful for SWR measurement and antenna tuning,

The VOX switch activates voice-actuated transmit/receive switching, and semi break-in CW keying. In SSB, AM & FM modes, when this switch is in the depressed position, the transmitter will be activated just by speaking into the microphone. When finished speaking or releasing the CW key (in CW mode), the receiver will be automatically reactivated after a short delay, as set by the DELAY control on the rear panel.

REAR PANEL CONTROLS & CONNECTORS

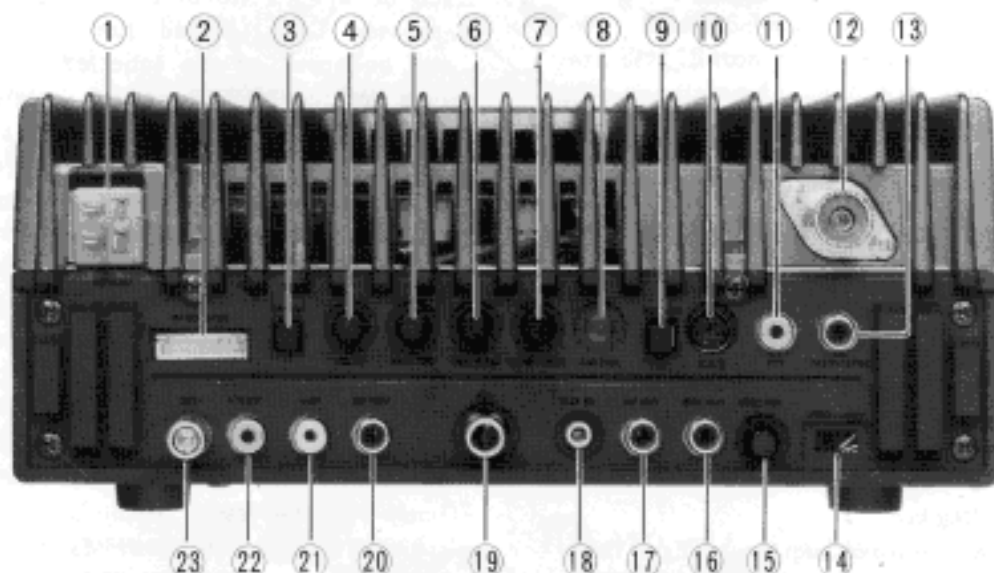

(1) DC 13.5V

This 4-pin connector accepts 12 to 15V DC at 19 amperes (transmit), to power the transceiver. Pinout is shown on page 13. CAUTION: AC voltage or DC outside of this range may damage the transceiver.

(2) BAND DATA

This 8-pin molex connector provides parallel TTL-level bandswitching signals (for the FC-757AT Antenna Tuner), and also QSK control signals for the FL-7000 Linear Amplifier. See the CAUTION notice on page 14 if you wish to use another model linear amplifier.

(3) LINEAR

This pushbutton switch activates external control of t/r switching by the FC-757AT, FL-7000 or other linear amplifier designed for QSK operation. If not using one of these accessories, this switch must be in the undepressed position for transmission. This switch also functions together with the MARKER switch to disable the memory backup, as described in the Operation section.

(4) DELAY

This control sets the delay between the time that speech stops or the CW key is opened and

the time that the receiver is reactivated when the VOX system is activated by the switch on the front panel.

(5) ANTI TRIP

This control sets the amount of negative receiver audio feedback applied to the VOX amplifier during VOX operation. The level should be set so that speaker audio does not key the transmitter.

(6) VOX GAIN

This control sets the gain of the VOX amplifier for VOX operation. The optimum setting depends on the microphone used and the voice characteristics of the operator.

(7) COMP LEVEL

This control sets the compression level of the audio speech compressor during SSB transmission with the processor (PROC switch) on. See the Operation section for adjustment.

(8) AM CAR

This (recessed) trimmer potentiometer sets the ratio of transmitted carrier to modulation for AM transmission. Adjustment is described in the Operation section.

(9) MARKER

Set this pushbutton switch to the depressed position to activate the 25kHz marker signal generator, which produces a carrier at multiples of 25kHz across the frequency range of the receiver. When the calibration signal is not needed, this switch should be off (out), to avoid interference with normal reception. This switch also functions in conjunction with the LINEAR switch to disable the memory backup as described later.

(10) CAT

This 6-pin mini DIN jack provides access to the serial data lines from the microcomputer and A/D converter, for control of the transceiver from an external computer. See the CAT section of this manual for details.

(11) PTT Jack

This phono jack provides access to the PTT line, for external receive/transmit control by a footswitch or other device. Connecting the inner contact to the outer contact (chassis ground) activates the transmitter. Maximum open circuit voltage present is 13.5V, and minimum closed circuit current is 0.3 mA.

(12) ANT Coaxial Jack

This type-M (SO-239) jack is for the antenna system, antenna tuner or linear amplifier input. Impedance requirement is 50 ohms, unbalanced. Use only a properly mating type-M (PL-259) plug and 50- or 52-ohm coaxial cable.

(13) PATCH/AFSK

This phono jack accepts transmitter input from a phone patch or AFSK tone generator. Impedance is 600 ohms, and the level should be externally adjusted to match that of the operator's microphone, producing the same power output with the same MIC gain control setting.

(14) FWD-REV

This switch selects meter indication of either forward or reverse relative rf power output during transmission, when the METER switch on the front panel is in the depressed (PO) position. Refer to the following description of the FWD SET control, and the description of SWR measurement in the Operation section.

(15) FWD SET

This potentiometer adjusts the sensitivity of the meter for forward and reverse PO functions during transmission. Adjust this control for full-scale meter deflection while transmitting a carrier with the FWD-REV switch set to the FWD position, so that SWR can be read on the meter in the REV position.

(16) EXT ALC

This phono jack accepts transmitter automatic level control voltage from a linear amplifier for the transmitter when the transceiver serves as an exciter. The applied voltage should be between 0 and -5V DC, referenced to the outer contact (chassis ground).

(17) AF OUT

This phono jack provides constant low-level receiver audio, unaffected by the AF gain control, for tape recording, digital demodulators capable of high impedance input or an external audio amplifier. Output level is approximately 200mV peak at 50 kilohms.

(18) EXT SP (External Speaker)

This 1/8-inch 2-conductor mini phone jack provides amplified receiver output to drive an external 4- to 16-ohm loudspeaker.

(19) KEY

This 1/4-inch 3-conductor phone jack accepts

keyer paddles for the internal electronic keyer, or a straight CW key (when the internal keyer is switched off). Wiring connections are shown on page 17. Open circuit voltage is +5V DC and closed circuit current is 0.5 mA.

CAUTION: None of the three KEY jack contacts are connected to chassis ground. DO NOT connect the outer contact to chassis ground.

(20) RF OUT

This phono jack provides low-level RF output from an early stage of the transmitter, for exciting a transverter.

Power level is approximately -6dBm (0.1 Vrms) at 50 ohms.

(21) +8V

This phono jack provides 8V DC at up to 100mA for low power accessories. The center contact is positive.

(22) +13.5V

This phono jack provides 13.5V DC at up to 500 mA for powering accessories. The center contact is positive.

Note: Repairs to damage caused by exceeding the current capabilities of the accessory DC jacks (+8V and +13.5V) may not be covered by the warranty policy.

(23) GND

For best performance and safety, connect this terminal to a good earth ground through the shortest path possible.

TOP COVER (KEYING) CONTROLS



(1) BREAK-IN

This slide switch selects semi or full break-in CW operation in conjunction with the MOX and VOX switches on the front panel, as indicated in the following chart.

| BREAK-IN | VOX | MOX | Resulting function |
|----------|-----|-----|-------------------------|
| SEMI | OFF | OFF | Siditone only (no tx) |
| SEMI | OFF | ON | Tx when keydown (no rx) |
| SEMI | ON | OFF | Semi break-in CW |
| FULL | OFF | OFF | Full break-in CW |
| FULL | OFF | ON | Continuous carrier tx |
| FULL | ON | OFF | Semi break-in CW |

(2) KEYER MAN/AUTO

When this switch is set to the AUTO position the internal 4-bit keyer microprocessor is activated. Keyer manipulator paddles must be connected to the KEY jack on the rear panel to operate the keyer. When a straight key or bug is used, set this switch to the MANUAL position.

(3) SPEED

This slide potentiometer sets the keying speed for the electronic keyer when the KEYER switch is set to AUTO and the keyer paddles are squeezed. Slide this control to the right for faster keying.

INSTALLATION

PRELIMINARY INSPECTION

Upon opening the packing carton, inspect the transceiver carefully for any signs of damage. Check to ensure that all exposed controls and switches move freely, and that the cabinet has no dents or scratches. If you notice any damage, document it completely and contact the shipping company immediately. Save the packing materials for possible future use.

BASE STATION INSTALLATION

AC Power Supply

The FT-757GXII requires a power source of 12 to 15 volts DC, capable of up to 20 amperes on voice peaks. For base station installations, Yaesu offers a variety of AC power supplies, all of which may be used with AC line voltages of 100, 110, 117, 200, 220 or 234 VAC. However, before connecting any power supply to the transceiver or AC line, make certain that the supply is properly set up for the local line voltage, and that the correct fuse is installed.

The **FP-757HD** is a heavy duty series regulator power supply capable of 50% duty cycle operation with full power transmissions for up to 30 minutes at a time. Forced-air cooling is provided over an extra large internal heat-sink. The FP-757HD requires a 6-amp fuse for 100, 110 or 117 VAC, or a 3-amp fuse for 200, 220 or 234 VAC. Power transformer primary connections for the different line voltages are shown on the next page.

The **FP-700** power supply may be used for light duty operation with the FT-757GXII (CW, SSB or reduced-power FM and AM). AC voltages, fuse requirements and power transformer wiring are the same as for the FP-757HD as described above and shown in the diagram on the next page, but the plastic sleeve on the supply DC cable must be cut to allow connection to the speaker in the power supply.

NEVER CONNECT AC POWER, OR DC ABOVE 15V, DIRECTLY TO THE FT-757GXII.

Make certain that the **POWER** switch on the front panel of the FT-757GXII is **OFF** (out) before connecting power to the transceiver, and double check to make sure that the polarity of the connections is correct before switching the transceiver on.



FP-700



FP-757HD

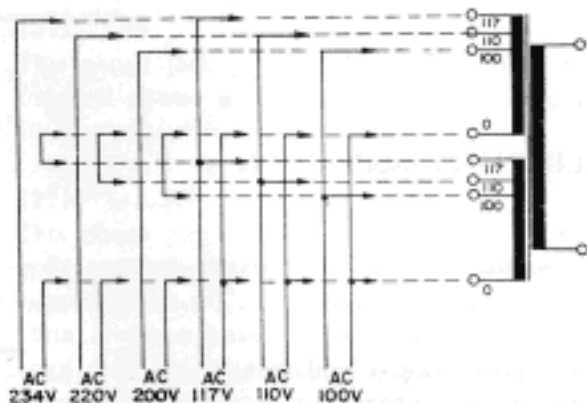

FP-757HD POWER TRANSFORMER PRIMARY CONNECTIONS

Equipment Location and Grounding

In all base station installations, the GND terminal on the rear panel of the transceiver should be connected by a heavy braided cable to a good earth ground. Best performance on all frequencies may require that the grounding cable be less than 10 feet (3 meters) long. All station equipment should have its own grounding cable (independent of signal or control cables), connected to a common point on the grounding bus, close to the transceiver or linear amplifier (if used). See the diagram below.

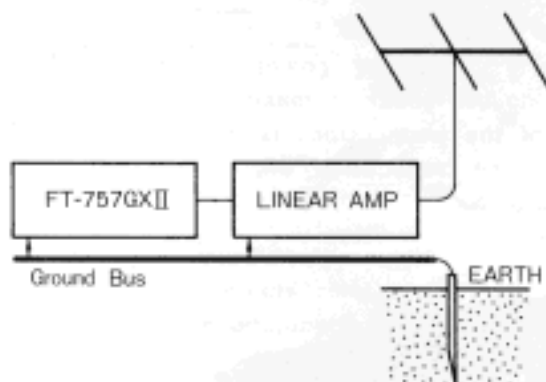

Locate the transceiver so that air can flow freely over the heatsink and under and behind the case. Avoid placing anything on top of the transceiver, and do not place the transceiver on top of another heat generating device such as a linear amplifier.

Antenna System

The FT-757GXII is designed for use with any antenna system having a 50-ohm resistive impedance at the operating frequency. Automatic final protection (AFP) circuitry is included in the transmitter to protect the final transistors by automatically reducing power output when an impedance mismatch (high SWR) is present. With an SWR of 3:1 for example, only about 75% of full power output is available.

Despite this protection, the FT-757GXII should never be switched to transmit when no antenna or dummy load is connected to the ANT jack. Use 50-ohm coaxial cable with a proper plug to connect the transceiver to the antenna or load, and if SWR is too high to permit the desired performance, connect an antenna tuner such as the automatic FC-757AT or the FC-700 between the transceiver and the antenna. See page 22 for SWR measurement with the FT-757GXII, and pages 14 - 16 for interconnection information.

MOBILE INSTALLATION

(Negative Ground vehicles only)

The DC power cable for mobile installation is supplied with the transceiver. Please review the NOTICE on page 11 before making power connections. The DC cable should be connected directly to the vehicle battery, rather than to the ignition or accessory circuitry. Route the cable as far away from ignition cables as possible, and then cut off any extra cable in order to minimize voltage drop losses.

- (1) Do not connect the cable to the transceiver until after the proper connections are made to the battery; the RED cable lead to the POSITIVE battery terminal, and BLACK lead to the NEGATIVE terminal. Make sure the battery terminal connections are tight, and remember to check them periodically for signs of loosening or corrosion.
- (2) Measure the voltage across the battery terminals with the engine running fast enough to show a charge. If above 15 volts, the automobile voltage regulator must be adjusted to reduce the charging voltage before proceeding.

- (3) Make sure the POWER switch on the transceiver is OFF, and connect the DC cable to the transceiver. The diagram below shows the plug pin connections. The positive RED wire must include a 20 amp fuse, installed in the supplied cable.

Always check to ensure that this switch is OFF before starting the engine.

FUSE Ratings: 20A for FT-757GXII,
6A for FT-757SXII

Mobile Antenna Installation

Please review the base station antenna information on the previous page. An antenna tuner such as the FC-757AT is particularly desirable in a mobile station, where the short antenna elements have very narrow bandwidth. Make sure that the shield of the antenna coax is firmly grounded to the car body at the antenna feedpoint.

Mounting

The optional MMB-20 Mobile Mounting Bracket for the FT-757GXII allows quick insertion and removal of the transceiver from the vehicle. Complete instructions are provided with the bracket, which may be installed either above or underneath the transceiver (see photo).

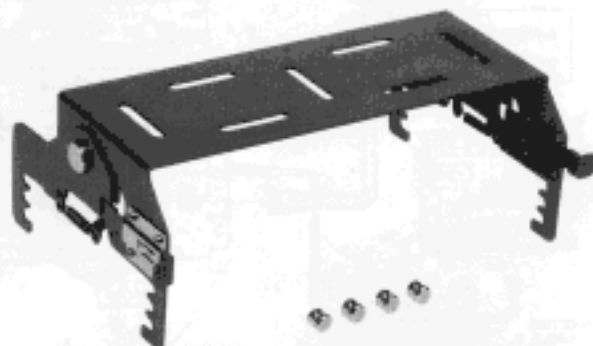
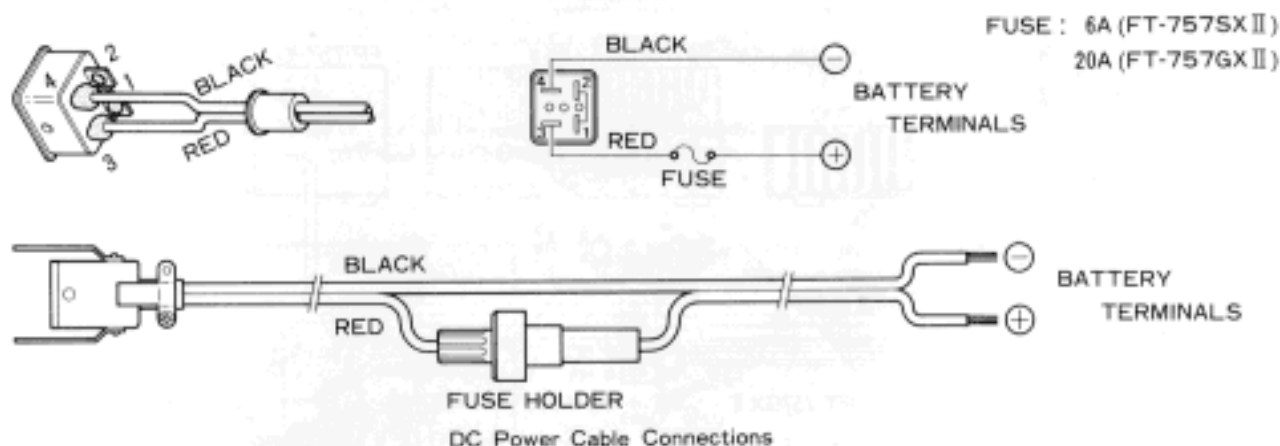

MMB-20 Mobile Mounting Bracket

INTERCONNECTIONS

Linear Amplifiers

The FT-757GXII includes a high voltage (150V) transistor switch capable of handling up to 1.5 amperes DC, to control transmit/receive switching of a linear amplifier via pin 6 of the BAND DATA jack. However, make certain that the t/r switching requirements of your linear amplifier do not exceed these limits, and that the linear switching voltage is +DC, and not -DC or AC. Yaesu offers the optional FRB-757 Relay Box for t/r switching of linears that require negative or AC switching, or higher voltage or current switching. The FRB-757 installs between the relay jack on the amplifier and the PTT jack on the transceiver, and is

capable of switching up to 250V AC or DC, at up to 2.5A.

If using the FC-757AT antenna tuner or a QSK linear amplifier such as the Yaesu FL-7000 or Alpha 78 connect pin 8 (INH, transmitter inhibit) of the BAND DATA jack to the exciter control line from the linear, and set the LINEAR switch to the ON (depressed) position to allow the transmitter activation circuitry in the linear to control the transceiver.

If using a non-QSK linear amplifier such as the Yaesu FL-2100B, or most Henry or Heathkit linears, make sure that the LINEAR switch on the transceiver is OFF (out).

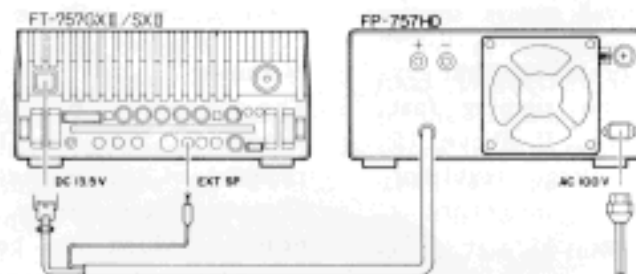

FT-757GX II / SX II + FP-757HD

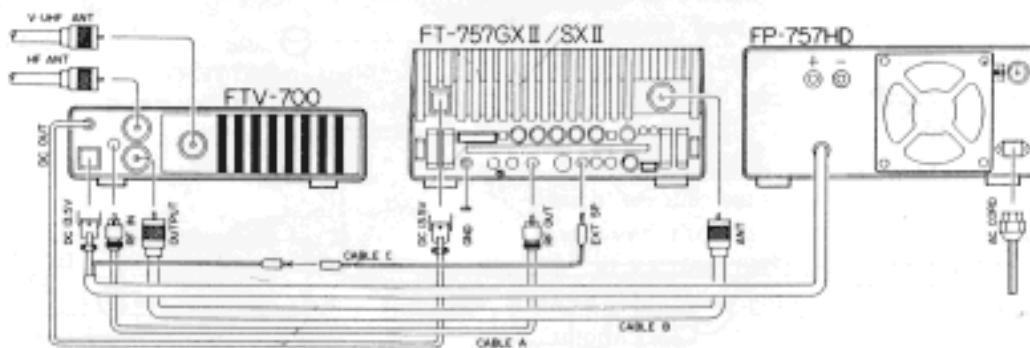

FT-757GX II / SX II + FTV-700 + FP-757HD

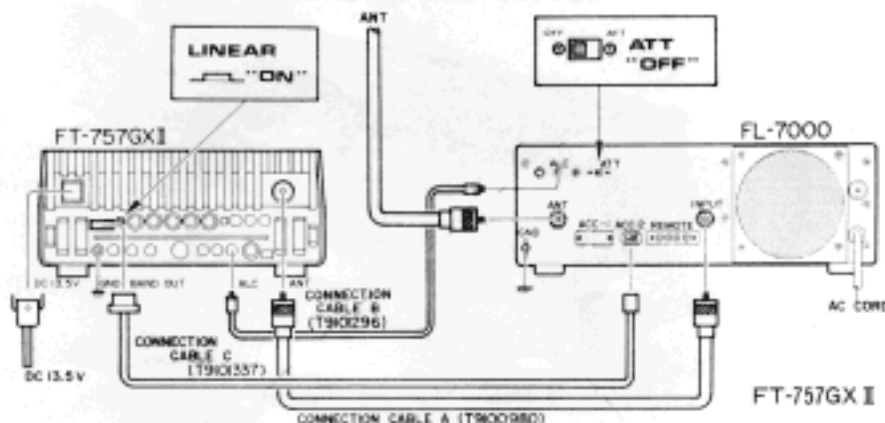

FT-757GX II + FL-7000

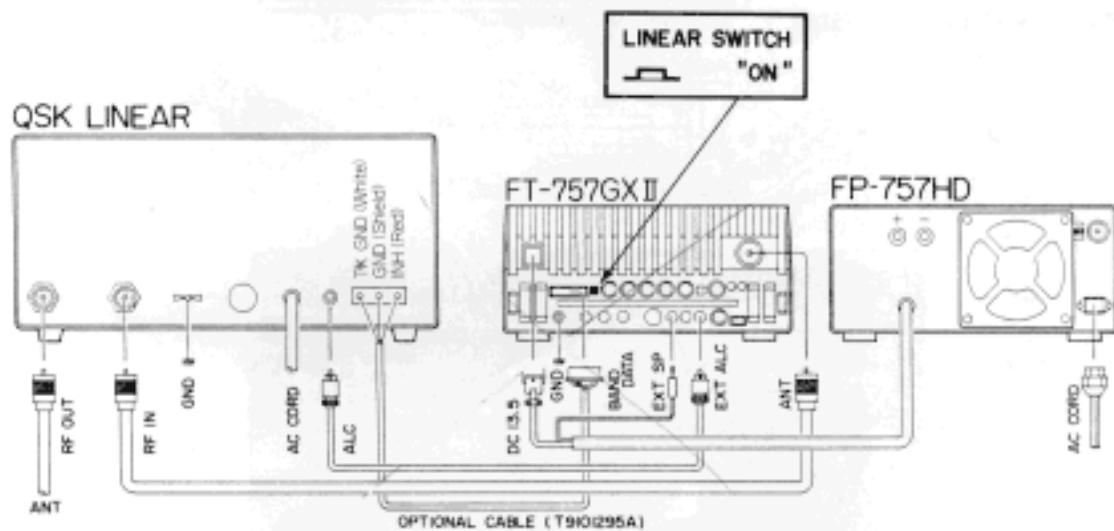
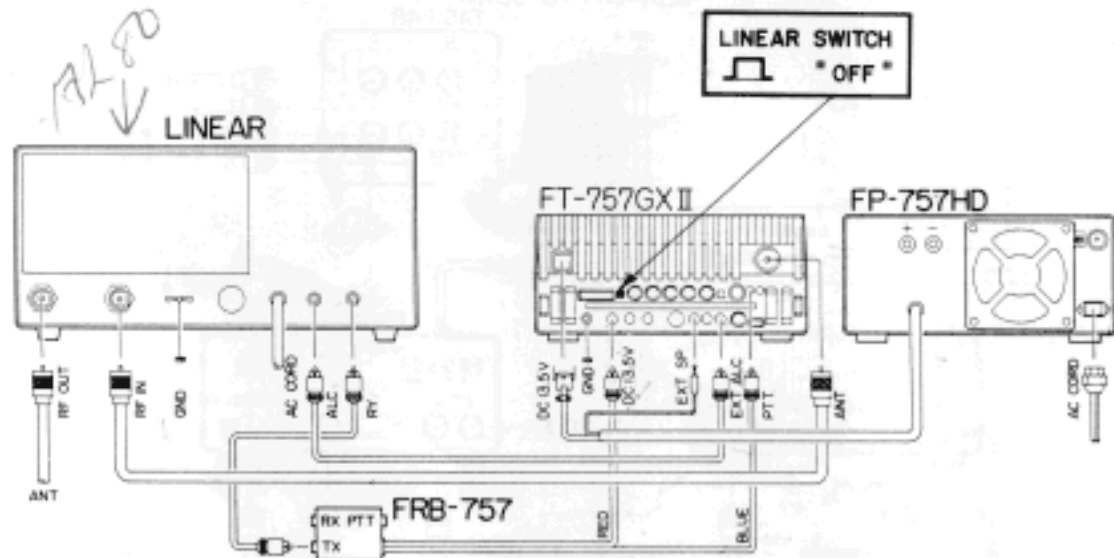

Note: Relay control voltage from the linear amplifier must be less than 50 V, and relay coil current less than 300 mA.

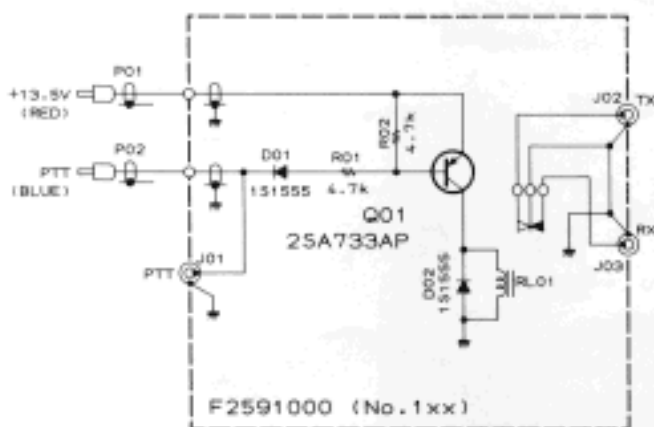

FRB-757
CIRCUIT DIAGRAM

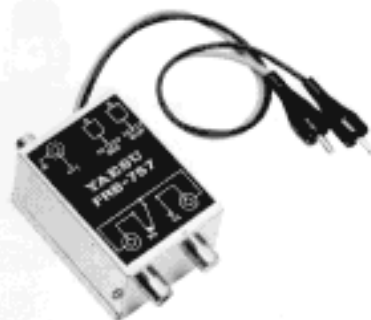
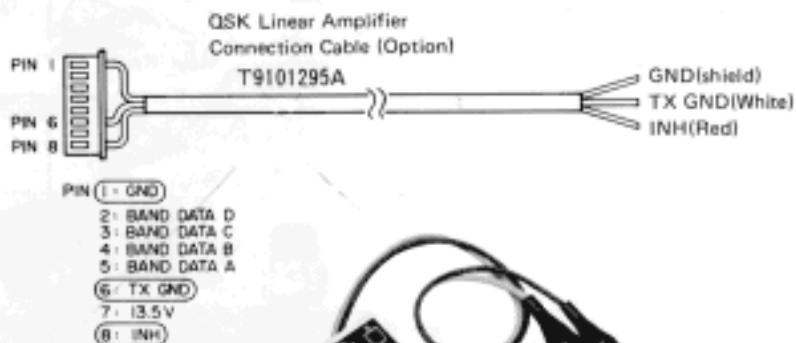

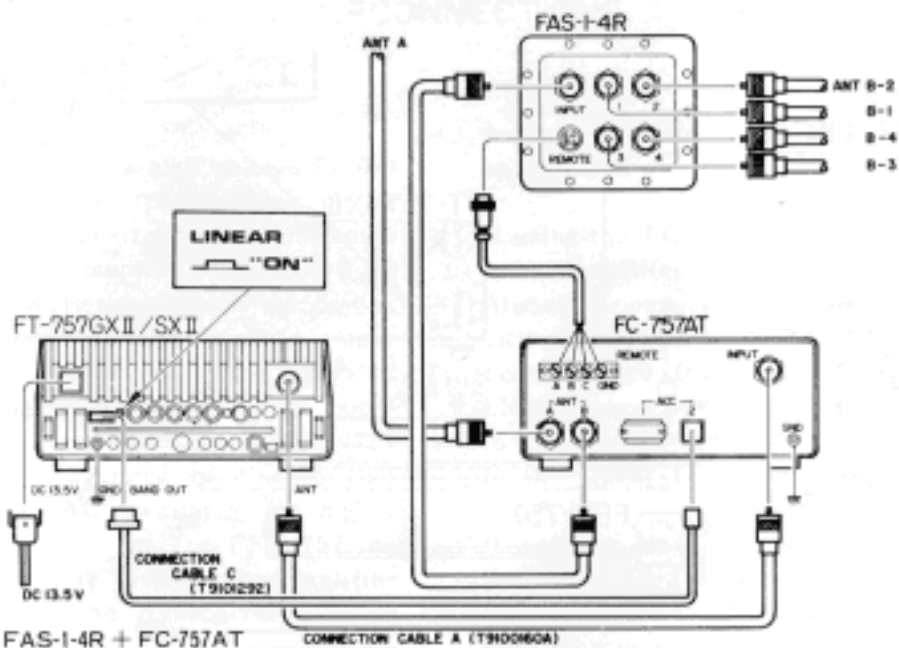

Main Knob

Torque Adjustment Screw

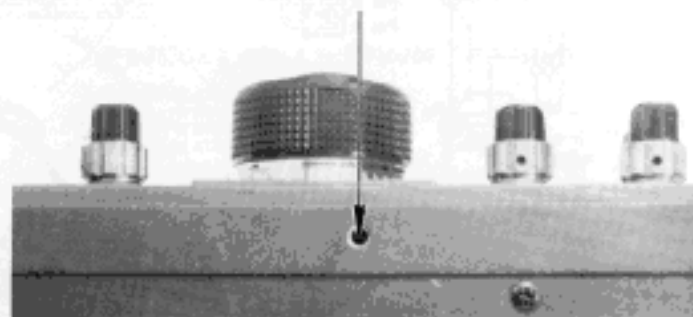

BOTTOM

MICROPHONES

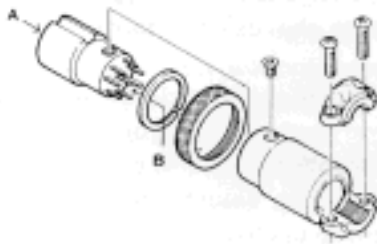

Plug assembly

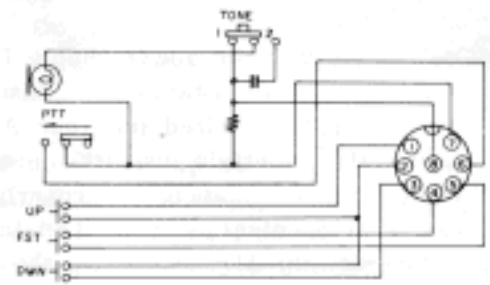

MH-188

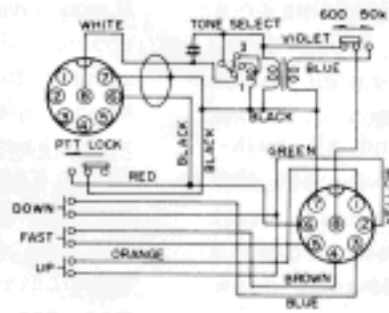

MD-188

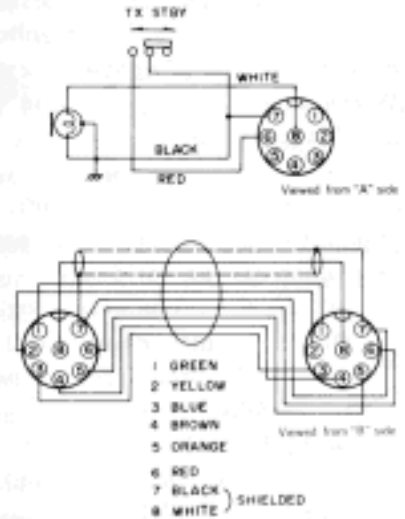

PLUG CONNECTIONS



Monaural Headphone Plug



External Speaker Plug



Stereo Headphone Plug



Manual key or External keyer Plug

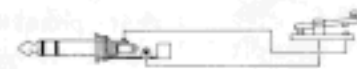

Automatic Keyer (Paddle) Plug

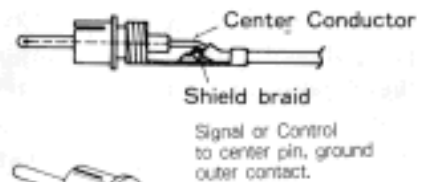

RCA Plug

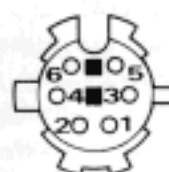

- ① GND
- ② S. OUT
- ③ S. IN
- ④ PTT
- ⑤ AGC
- ⑥ NC

CAT (Mini-DIN) Plug

OPERATION

Before plugging the power supply into the wall outlet (in base installation), ensure that the power supply is wired for your AC line voltage. Make certain that the proper fuse is installed, and that it is properly connected to the transceiver as described in the Installation section. Also make sure the antenna and ground are connected. Refer to the Memory Backup information below to enable the backup.

Connect a microphone, if desired, to the MIC jack. See page 17 for microphone information. For CW operation, connect keyer paddles or a CW key as shown on page 17 to the KEY jack on the rear panel.

Preset the POWER switch off, and all push-buttons to the undepressed position. Set the other controls as follows:

- MIC - fully counterclockwise
- DRIVE - fully counterclockwise
- AF - fully counterclockwise
- RF - fully clockwise
- NOTCH - fully counterclockwise (into the OFF clickstop)
- SHIFT - 12 o'clock position
- NB - 12 o'clock position.

Initial Power Up and Tuning

Make sure that the MOX and VOX buttons are in the undepressed (out) positions, and then switch on the power supply, followed by the transceiver POWER switch. The meter and display should light, with the display indicating the default (memory clear) state: VFO A and 7.000.0. Also, the green GEN and yellow LSB indicators should light (also defaults).

Press the H/G key and observe the steps of the DWN and UP keys (the GEN indicator is off for amateur band steps), and then press DWN and UP keys to select the operating band (for which the antenna is resonant).

The Ham/Gen (H/G) selection affects only the stepping action of the DWN and UP keys when tuning a vfo. You can use either selection to receive on any frequency, or to transmit in the amateur bands. The transmitter is disabled outside of the 500 kHz amateur band segments regardless of Ham/Gen selection.

Press the MODE button (repeatedly, if necessary) to select the desired mode of emission.

Turn the AF gain control clockwise for comfortable receiver volume. If you do not have a scanning microphone, use the FAST button on the front panel to select course tuning steps (with the tuning knob), and then set the FAST button off (undepressed) for fine tuning. Notice that both coarse and fine tuning steps are mode-dependent, as shown on page 6.

If you have an MD-1B8 or MH-1B8 scanning microphone the scan keys on the microphone can greatly facilitate vfo tuning with the tuning knob: operate the tuning knob with one hand while keeping your other hand on the microphone, FAST button. This allows quick searching for activity (with the FAST button pressed), and then easy fine tuning when the FAST button is released. To jump up or down one coarse step, press the microphone FAST and either UP or DOWN key together.

NOTE: Under certain conditions the tuning knob is deactivated. These are when the D LOCK (dial lock), MR (memory recall) or SCAN MODE functions are active. When the dial is locked or a memory has been recalled, 'LOCK' and 'MR' appear, respectively, on the display. Press the D LOCK button to deactivate the dial lock, or press the MR/VFO button to return control to a vfo. If neither of the above-mentioned conditions is displayed reset the SCAN MODE button to the undepressed position to turn off the scanner.

Memory Backup

Before leaving the factory the memory backup system is turned off. Activate the backup by setting the MARKER and LINEAR switches on the rear panel to their undepressed (off) positions. If you are using a QSK linear the LINEAR switch must be kept in the depressed position, in which case only the MARKER switch needs to be set to off.

If you want to clear all memories, or if you plan to store the transceiver for a long time without power connected, disable the backup system by pressing both the LINEAR and MARKER switches (to ON) while the transceiver is off.

SSB Reception, Interference Reduction

Except for the vfo and memory control keys, the remaining controls for the receiver are provided to reduce or eliminate the various types of noise, interference and distortion that can obstruct comfortable reception. Operation is first described for SSB (USB or LSB) reception on an amateur band, with variations for other modes described later.

Press the MODE button to select USB and tune to the 14, 21 or 28 MHz phone band (if your antenna is for a band below 10 MHz, select that band and the LSB mode). Also, set the AGC-F button for fast agc action (depressed).

RF AMP & Attenuator

Careful adjustment of the receiver front end is necessary for optimum reception, and should be treated as first priority at the start of an operating session, or when changing modes, bands or antennas. To set up the receiver for optimum sensitivity, first make sure the RF gain control is fully clockwise, and the rf amplifier and attenuator are off (RF AMP and ATT undepressed).

On a clear frequency, check for any S-meter reading on the background noise level (hiss or crackle). If the S-meter deflects above 3, turn on the attenuator (press ATT). Otherwise, if the background noise gives no deflection, turn on the RF AMP and again note the S-meter reading on background noise: if it is above 3 S-units, turn the RF AMP back off (leaving it on would increase the S-meter readings of received signals, but would not improve the signal-to-noise ratio (real sensitivity), and would increase the likelihood of overload from strong signals on other frequencies.

After selecting the proper ATT and RF AMP settings, if background noise still causes the S-meter to deflect, note the level and then rotate the RF gain control counterclockwise from maximum until the S-meter deflection just begins to increase slightly above the noise level. This will reduce the background noise when you listen to signals.

In general, the attenuator may often be needed on frequencies below 10 MHz, and when you are using a large antenna or your station is in a noisy environment (city). The RF AMP should

rarely be needed below 10 MHz, unless you have a small antenna or your station is in a quiet environment. Do not activate the attenuator and RF AMP at the same time; instead, switch both off.

The settings described up to this point are best for tuning and receiving weak signals under most conditions. In most cases, once you have tuned in a station, you will want to set the AGC-F off (out, slow agc) for most comfortable listening. If you are working a strong station (consistently above S-9), turn on the the attenuator if it isn't already on, or turn off the RF AMP (if it's on), and decrease the RF gain so that his signal just moves the S-meter above its (raised) resting position. You should notice a reduction in background noise and more comfortable copy.

When retuning the vfo, set the AGC-F back on (fast), and return the RF and ATT to their previous settings (if you are listening for weak signals).

IF Shift & Notch Filter

If you experience interference from stations on nearby frequencies after tuning in a station and setting the rf controls as just described, rotate the SHIFT control to suppress the interference. Usually, interference on one side of the desired signal is worse than on the other, and by shifting the passband toward the clearer side reception of the desired signal can be improved. Notice, however, that the passband of the -desired signal is also shifted, so turning the SHIFT control too far may cut off too much of the low or high audio components and make the signal unintelligible.

The IF notch filter is primarily useful for suppressing heterodynes in CW and ECSS reception as described later. However, it is also a powerful tool for suppressing other types of interference, such as computer generated buzzing noise, in the SSB mode. After tuning in the desired signal and setting the SHIFT for optimum copy, if you are receiving a buzzing type noise, turn the NOTCH on (out of the click stop), and watch the S-meter while tuning the notch control for minimum deflection on the noise (when the other station isn't talking). Of course this same technique can be used to suppress interfering CW signals or carrier heterodynes during SSB reception.

Note: once the NOTCH has been set, adjusting the receiving frequency or the SHIFT control will move the notch setting, which will then have to be readjusted.

Another powerful application of the IF notch filter is to effectively narrow the receiving passband by tuning the notch near the high or low edge. The result is illustrated in the diagram below. First tune in the desired signal and adjust the SHIFT as described above. Then turn on the NOTCH and adjust it to the opposite end of the passband from that rejected by the SHIFT, for best noise rejection and receiving clarity.

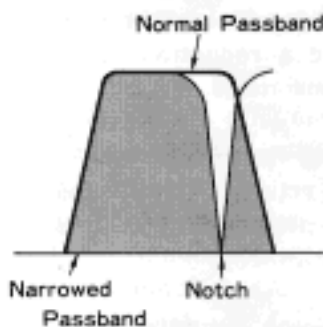

Remember to return the NOTCH control to its off (clickstop) position, and the SHIFT control to its center position when retuning to another frequency.

Noise Blanker

Pulse-type noise, either short duration types such as from ignitions systems and electric motors and switches, or long duration over-the-horizon radar ("woodpecker") signals, can be reduced or removed by pressing the NB button and adjusting the NB control from counterclockwise to clockwise just to the point where the noise is removed. Rotating the NB control too far may cause distortion of the desired signal, or intermodulation if strong signals are present on nearby frequencies. When noise blanking is not required the NB button should be in the off (out) position.

Squelch (All mode)

When waiting for a scheduled call on fairly uncrowded band the squelch can be activated to silence the receiver until the call. Just tune to the scheduled frequency (or set the scanner, as described later, to scan the desired range), and then turn the SQL control until the receiver is quiet. Of course this will

only work if the expected signal is strong enough to overcome the squelch threshold. Otherwise, when not scanning, the SQL control should be set fully counterclockwise.

Note: Whenever using the squelch feature, make sure to set up the RF AMP, ATT and RF gain as described previously before adjusting the SQL control, as the squelch threshold is affected by these front end settings.

CW Reception

In addition to the interference and noise reducing controls described for SSB, the FT-757GXII CW-N (narrow) mode provides a 600 Hz IF filter to enhance reception. Use the CW-W (wide) mode to tune in the desired signal for about an 700 Hz pitch, and then press the MODE button to select CW-N.

Keep the AGC-F switch in the fast (depressed) position for CW reception, and reduce the RF gain as much as possible to suppress background noise.

The CW-W mode provides the same IF bandwidth as for SSB, but with a special internal audio filter to reduce the audio bandwidth, allowing you to hear signals up to about 1 kHz away while tuning around the band. Noise and interference are greater than for CW-N, but the wider bandwidth makes tuning easier.

The NOTCH filter is useful in both wide and narrow CW modes to suppress a stronger nearby CW signal in order to hear a weaker one. Just turn the NOTCH control to set the notch on the undesired signal. This should be done both by ear and by observing the S-meter for a dip.

Hint: when you make contact with another station on CW, press the D LOCK button to avoid accidental frequency change.

AM Reception

The FT-757GXII includes a 6 kHz filter for good fidelity during reception of medium- and shortwave AM broadcasts. The NOTCH filter is useful for eliminating carrier heterodynes (whistles) produced when two stations are transmitting near the same frequency, but when not needed, it should be switched off for best fidelity. The SHIFT control is less effective than in the narrower modes, but it is useful for eliminating high-pitch hiss and heterodynes from stations more than 3 kHz away.

When interference or noise is severe, ECSS (Exalted Carrier Selectable Sidedband) reception may be preferable for receiving AM signals. This special technique allows you to select either the upper or lower sideband of an AM signal; eliminating interference that may be present on the other sideband due to a nearby signal. It also provides greater selectivity resulting in greater sensitivity and SHIFT control effectiveness, but does not provide as much fidelity for strong signals as the AM mode.

To use the ECSS technique, first tune in the station precisely (shortwave broadcasters generally transmit on precise multiples of 5 kHz) using the AM mode, and then select either USB or LSB, whichever gives best reception.

Now carefully fine tune for zero beat on the received carrier. To hear the carrier, set the SHIFT control all the way in the direction that gives emphasis to bass, and very slowly tune for the point where the signal sounds most natural and undistorted, with no accompanying whistle or dissonance.

When you have tuned to zero beat, return the SHIFT control to center (or adjust for minimum interference and the desired tone), and push D LOCK so you don't lose the frequency.

Hint: Zero beating an AM signal in ECSS reception requires a very careful touch on the tuning knob. Some practice with stronger signals first will make tuning the weak ones easier. Coarse tuning cannot be used for ECSS.

When receiving AM signals in either AM or ECSS mode, the noise blanker should be off unless it is really needed. Its effectiveness will vary depending on the signal strength of the

received signal and those on adjacent channels; being most effective when the signals are weak and noise pulses are strong.

FM Reception

The FT-757GXII is equipped for FM operation without additional accessories. However, FM is generally not used on frequencies below 29 MHz, so a VHF or UHF transverter may be used to extend the range of the FT-757GXII to the amateur bands above 30 MHz.

The SHIFT, NOTCH, Noise Blanker and AGC controls are not active in FM reception. However, the RF AMP, RF gain, ATT and SQL settings are especially important. For weak signal work, set the SQL control only after the other controls have been set. The FT-757GXII FM circuitry is designed for ± 5 kHz deviation, as is most common in 2-way FM communications.

RTTY and Packet Reception

An external TU (terminal unit) or TNC (terminal node controller) is required for RTTY or packet operation, respectively. Receiver audio is best obtained from the AF OUT jack on the rear panel, as the level of the signal at this jack is not affected by the AF gain control. However, your TU or TNC must be capable of high impedance input (200mVp-p @50-kilohms) to use this signal. Otherwise, low impedance output is available from the EXT SP jack, but this is affected by the AF gain control, and using this jack disables the internal speaker.

The SHIFT control is especially convenient for RTTY and hf packet operation, using the SSB modes (generally LSB is used for amateur digital modes below 29 MHz). Set the SHIFT control so that fsk tones are centered in the passband (the center position is 1500 Hz).

As for SSB, the NOTCH filter may be adjusted to suppress an unwanted carrier, or to narrow the passband after the SHIFT control has been set. The agc should be fast (AGC-F depressed), and the noise blanker may be left on at a moderate setting (about 10 or 11 o'clock).

TRANSMITTER OPERATION

The solid state transmitter in the FT-757GXII requires no adjustment other than setting the desired output level. The maximum power output is determined by the mode and the capability of the power supply (in AM, FM and afsk, power may have to be restricted to avoid overheating the power supply). Also, there are certain precautions to be observed at all times when transmitting to avoid possible damage to the transceiver, and to assure a clean signal.

Never transmit without having a dummy load or antenna tuned to the operating frequency connected to the transceiver (or linear amplifier, if used). If you have any doubt of the suitability of a particular antenna on a certain frequency, check the SWR (Standing Wave Ratio) first, as described below.

Avoid changing frequency during transmission. First return to receive, tune to the new transmit frequency, and listen for at least a minute or two to make sure it is not already occupied; or ask if the frequency is occupied and then listen for a response. When using a light- or medium duty power supply such as the FP-700, do not attempt to transmit FM, AM or fsk at full output power. Although the transceiver is capable of this, some power supplies are not, and they may rapidly overheat and be seriously damaged. In any mode, feel the supply occasionally and reduce power or stop transmitting for a while if it feels hot.

Never begin to transmit (except into a dummy load) without first listening for a few minutes to make sure the frequency is clear, and then transmit your call sign. This will avoid accidental interference to other stations.

SWR Checking & Measuring

Before transmitting, the SWR of the antenna system should be checked at the operating frequency to ensure that the proper impedance is being presented to the transmitter. The transmitter includes protection circuits that will automatically reduce the output power if SWR is high. For example, with an SWR of 3:1 only about 75% of full power is available.

If using the FC-757AT Automatic Antenna Tuner or FL-7000 Linear Amplifier, SWR is calculated and displayed automatically, and the following procedures are not necessary. In this case,

keep the METER switch on the FT-757GXII in the ALC (undepressed) position. See the Tuner or Amplifier manual for complete details.

Keying the Transmitter

Use the MOX button to activate the transmitter during the following procedures. Before beginning, set the BREAK-IN switch on the top panel to FULL, and the VOX button on the front panel to off (out). To transmit, set the MOX button to the depressed position, and then press it again to receive (undepressed position).

SWR Checking

This procedure checks the approximate SWR using just a few watts, to avoid interference and strain on the equipment when SWR is unknown, such as on a new antenna.

- (1) On the rear panel, set the FWD-REV slide switch to the FWD position, and turn the FWD SET control fully clockwise (as viewed from the rear).
- (2) Make sure the DRIVE control is set fully counterclockwise. Set the METER switch to the PO (depressed) position, and select the CW-W mode.
- (3) Tune the vfo to a clear frequency, and listen for a minute to make sure its clear before proceeding.
- (4) Press the MOX button (the red ON AIR indicator will light), and very gradually advance the DRIVE control while watching the meter for any deflection. Now adjust the DRIVE control so that the meter deflects exactly to the SET marker (white line cutting the red bar at the right side of the SWR meter scale).
- (5) Set the MOX switch back off (out). Reach back around to the rear panel, and move the FWD-REV slide switch to the REV position. Now press the MOX switch again to key the transmitter, and note the SWR approximation on the bottom scale of the meter. Press the MOX switch again to return to receive.

If the SWR indication was above 3, the antenna system is too far from resonance to be used at the test frequency without substantially degraded performance (not recommended). SWR

indication close to 3 indicates a poor antenna match at this frequency, but an antenna tuner such as the FC-757AT may be used to match the antenna better, reducing the SWR. Of course this will not change the radiating qualities of the antenna itself, and will require retuning whenever the transmitting frequency is changed, so it is better to correct the antenna or feedline mismatch first, if possible.

SWR indications of 1.5 or less indicates a matched antenna for use at the test frequency.

SWR Measuring

Use full power to measure SWR more precisely:

- (1) Set the FWD SET control on the rear panel to midrange, and set the FWD-REV switch to FWD. Use the CW-W mode and MOX button as above for the following steps.
- (2) Set the METER switch to ALC (out).
- (3) Make sure the frequency is clear, and then press the MOX button and advance the DRIVE until the meter just begins to deflect.
- (4) Press the METER switch to PO (in).
- (5) While still transmitting, carefully reach around to the rear panel and adjust the FWD SET control for full scale deflection to the SET mark on the meter.
- (6) Move the FWD-REV switch to REV, and note the SWR reading on the bottom scale of the meter. Set the MOX button off (out).

Again, if the SWR is above 3, a change in the antenna system is recommended for operation on this frequency.

Power Meter Calibration

The meter may be calibrated using the CW mode to indicate approximate transmitter RF output power in watts as follows. This is necessary for proper transmitter adjustment for AM, FM and RTTY or packet transmission, and is helpful for reduced power operation in other modes. If using the FC-757AT Antenna Tuner this procedure is not necessary, as the FC-757AT includes a wattmeter and dummy load.

Before beginning, measure the SWR as described above and make sure the antenna is properly matched, or connect a 50-ohm dummy load.

- (1) With the MOX switch off, select the CW-W mode, set the METER switch to PO (in), and set the DRIVE control fully clockwise (maximum). On the rear panel, set the FWD-REV switch to FWD.
- (2) Check that the frequency is clear, then press the MOX button and carefully adjust the FWD SET control on the rear panel so that the meter indicates 100W on the PO (center) scale. Return the MOX button to off (receive).

The accuracy of this calibration is very rough, as the actual full power output depends on the band of operation and the antenna SWR. If you have an accurate wattmeter and 50-ohm dummy load, you can use these in the above procedure. Set the DRIVE control for 100W output before adjusting the FWD SET control.

SSB Transmission

With a microphone connected to the MIC jack on the front panel, ensure the following controls are preset as indicated:

- METER selector ALC (out)
- MIC gain control 12 o'clock (inner knob right of the MIC jack)
- PROC switch OFF (out)
- VOX switch OFF (out)
- MODE select LSB or USB

Tune to a valid transmitting frequency (in the amateur bands).

To activate the transmitter, close the PTT switch on the microphone, and watching the ALC indication (blue scale) on the meter, adjust the MIC gain control so that the meter deflects within the ALC zone (heavy blue line on the scale) on voice peaks. This will result in full power output; reduce the MIC gain to reduce power.

Speech Processor

After setting the MIC gain as above, press the PROC switch to activate the processor. The average ALC indication on the meter will increase, but if the peak indication deflects past the ALC zone, reduce the MIC gain.

The COMP LEVEL control on the rear panel adjusts the level of speech processor compression, and is carefully set for optimum performance at the factory. However, using different microphones or variations in voice pitch may make it desirable to readjust this control. This can be done by monitoring the transmitted signal on an oscilloscope or external receiver and adjusting the COMP LEVEL control to the point just below that at which distortion appears on the signal. If set beyond this point, average power will still be increased, but distortion will cause signal intelligibility to be decreased.

VOX (Voice-actuated Transmit Switching)

In any of the voice modes, you can use the VOX system to automatically activate the transmitter when you speak into the microphone. Press the VOX switch to activate VOX, and then adjust the VOX control on the rear panel so that the transmitter activates when you speak (without pressing the PTT switch on the microphone). When you stop talking the transceiver should return to receive after a slight delay. The DELAY adjustment on the rear panel sets the hang time for VOX switching from transmit to receive.

If the audio from the receiver triggers the VOX system, make the above adjustments with the AF control set for low volume. Then increase the volume to the desired operating level and adjust the ANTI-TRIP control on the rear panel just to the point where receiver audio from the speaker ceases to trip the VOX.

Clarifier (Receiver Offset)

When receiving on a vfo, the CLAR button can be pressed to allow independent tuning and mode changing of the receiver without affecting the transmit frequency (CLAR is displayed to the left of the operating frequency). This feature is useful if, after making contact with another station, his transmitter drifts; you can retune his signal without changing your own transmitting frequency. Also, since the range of the clarifier is unlimited, it can be used for split frequency operation.

While the clarifier is on the tuning knob and mode selector affect only the receiver: the transmitting frequency and mode will remain the same as before the clarifier was activated, and this frequency and mode will be displayed when transmitting.

The FT-757GXII incorporates a special 'clarifier memory', which allows you to listen on the transmit frequency by switching off the clarifier. As long as you don't touch the tuning knob, pressing CLAR again returns you to the (offset) receive frequency.

When the contact is finished, remember to switch off the clarifier so that the transmit and receive frequencies and modes will be re-aligned when you retune.

CW Transmission

The FT-757GXII offers both semi and full break-in (QSK) operation for both simplex and split-frequency operation. However, QSK operation must not be attempted while using a linear amplifier not specifically designed for it, or damage to the amplifier or transceiver may result. See page 14.

The FT-757GXII includes an internal electronic keyer, which can be used by connecting keyer paddles to the KEY jack. You can also use a straight key or an external electronic keyer, in which cases the internal keyer must be switched off (top panel KEYSWITCH to MAN). Be careful not to short the outer contact of the KEY jack to chassis ground.

Set up the following front panel controls:

- VOX switch ON (depressed)
- METER switch ALC (out)
- DRIVE control clockwise (max)
- MODE switch select CW-W or CW-N

Also, on the top panel, set the KEYSWITCH to MAN initially. Close the key to activate the transmitter, and adjust the DRIVE control so that the ALC meter just starts to deflect. This setting provides full power output: after making contact with another station, reduce power with the DRIVE control if you can without losing contact.

You should be able to hear the sidetone from the loudspeaker (or headphones) when you close the key. The sidetone control (inside the hole near the rear of the bottom cover) can be adjusted for comfortable sidetone volume.

To set the (internal) keyer speed or to practice sending CW, set the VOX switch off (out), and the BREAK-IN switch to SEMI. Also set the KEYSER switch to AUTO if using keyer paddles. Now, closing the key will generate the sidetone but no signal will be transmitted. Adjust the KEYSER control for the desired speed.

For QSK transmission set the VOX switch OFF (out) and BREAK-IN to FULL.

For semi break-in operation, as required with some linear amplifiers, set the VOX switch ON (depressed) and BREAK-IN to SEMI. The DELAY control on the rear panel adjusts the hang time between key-up and receiver enable.

FM Transmission

For FM transmission, just select the FM mode and close the PTT switch to transmit. The MIC gain control is disabled for FM, as the gain of the microphone amplifier is preset internally for 5 kHz deviation, and should require no further adjustment. RF power output is adjusted by the DRIVE control. For full power output (using the FP-757HD power supply), adjust the DRIVE so that the meter (set for ALC) just deflects slightly. When contact is established, reduce the DRIVE.

CAUTION

When the FT-757GXII is used with the FP-757HD power supply, full power FM, AM or AFSK (RTTY) transmissions must be limited to 30 minutes maximum.

When the FP-700 or other light-duty supply is used, transmitter power in the above modes must be limited to 50 watts at all times, to avoid overheating and subsequent damage to the supply.

Regardless of the power source or mode, we recommend reducing power from the maximum levels mentioned above whenever transmitting for more than 10 minutes, or if the ambient air temperature is very hot or the power supply feels hot.

AM Transmission

Because carrier power is only one fourth of the total PEP of an AM signal, it must be limited to 25 watts or less when transmitting with the FT-757GXII. When the power of the modulating sidebands is added to the carrier power, actual PEP output is 100 watts, although this does not show on the meter.

To adjust the FT-757GXII for AM transmission, first calibrate the PO meter as described on page 26, or use an external wattmeter.

- (1) Preset the MIC gain fully counterclockwise, and set the METER switch to PO.
- (2) Make sure the frequency is clear, and then close the PTT switch on the microphone and advance the DRIVE for power output of 25 watts or less on the transmitted carrier.
- (3) Set the METER switch to ALC (out). Speak into the microphone and advance the MIC gain control until slight movement of the meter occurs on voice peaks. PEP output is now 100 watts. Do not advance the MIC gain further, or overmodulation (and distortion) may result.
- (4) Use the DRIVE control to reduce power once contact has been established.

The AF speech processor can be activated for AM transmissions by pressing the PROC button. However, if speech processing is necessary to maintain contact, we recommend switching to an SSB mode for higher efficiency.

The VOX system and clarifier control can also be used for AM, as described for SSB.

The AM CAR control on the rear panel adjusts the modulation percentage for a given carrier level. This control is aligned at the factory to provide 100% modulation when the DRIVE control is set for a carrier level of 25 watts, and the MIC gain control is set to about the same position as required for full power output in SSB. For 100% modulation with a lower carrier level, the AM CAR control can be readjusted with an oscilloscope connected to monitor the RF output.

To set the AM CAR control for 100% modulation at full power output, use an RF voltmeter for the following steps;

- (1) Connect the RF voltmeter to jack J1023 on the RF Unit.
- (2) Select a CW mode, and note the voltmeter reading with the transmitter keyed.
- (3) Return to receive, select the AM mode, key the transmitter and with no modulation, adjust the AM CAR potentiometer for exactly one half of the voltage that was measured in the CW mode.

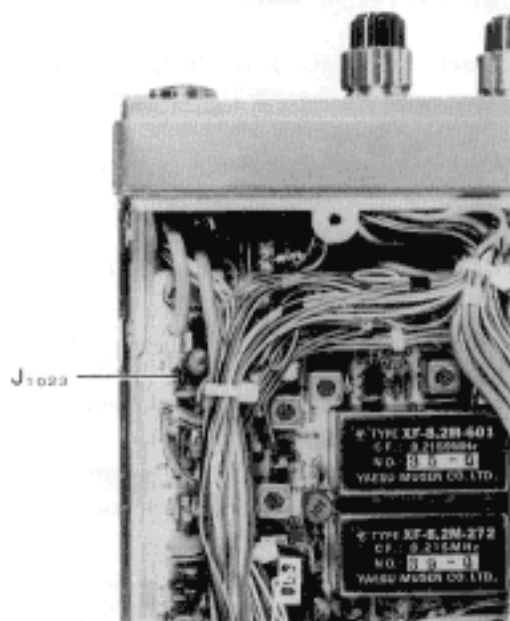

Unless using a heavy duty power supply, keep transmissions short, and stop transmitting if the power supply becomes hot.

RTTY, HF Packet & SSTV Transmission

Transmission of narrowband FSK (F1; RTTY, SSTV and Bell 103 HF packet) requires input of equal level audio tones (AFSK) at the 600-ohm PATCH jack on the rear panel. Remove the microphone from the MIC jack so that extraneous sounds do not interfere with your trans-

mitted signal. Select LSB or USB mode, and set the PROC switch off.

The PTT jack on the rear panel may be used for external transmit/receive control, or press the VOX button to allow automatic transmit/receive switching (either full or semi break-in may be used). Manual transmit/receive control is also possible with the MOX button.

Note that the displayed frequency is the (suppressed) carrier frequency, so your actual MARK and SPACE frequencies will be displaced from the display by the audio frequencies of the tones.

Use the MIC gain control to adjust power output while transmitting: for full power, set the MIC gain so that the meter (showing ALC) deflects slightly. Reduce power output by turning the MIC gain counterclockwise from full power and observing power output on the PO meter (after calibrating as described previously), or on an external wattmeter.

As mentioned previously, the FT-757GXII is capable of full power AFSK transmission for limited periods when used with a heavy duty power supply. Restrict transmissions to 30 minutes with the FP-757HD. If using the FP-700, restrict RTTY or packet power output to 50 watts maximum. However, if the air temperature is high or at high altitudes, cooling efficiency is decreased and so power output should be reduced accordingly. Also, it is a good practice to back off on the power whenever making a long transmission, and even then supply temperature should be closely monitored.

After transmitting, if the cooling fan is on, don't turn the POWER switch off until the set has had a few minutes to cool and the fan to switch off.

MEMORY OPERATION

Ten memory channels, numbered 0 through 9, are available for storing operating frequency and mode of emission selected on a VFO. In addition there are two VFOs denoted VFO A and VFO B and a 'clarifier memory', each of which hold both operating frequency and mode independently, giving a total of 13 memories. Selection and manipulation of the memories and VFOs is accomplished via the six keypad keys at the upper right corner of the front panel.

Note that the VFO►M and M►VFO keys have yellow marking in the notch on the keyfaces. This is intended to serve as a caution that these keys cause data to be overwritten (erased).

VFO A/B Selection

The operating vfo is indicated by VFO A or VFO B displayed to the left of the operating frequency. Each vfo holds an independent frequency and mode of emission. To select the alternate vfo, press the VFO A/B key.

VFO/Memory Selection

The MR/VFO key at the upper right selects between memory and vfo operation. Whenever this key is pressed, the selected vfo or memory and its displayed frequency and indicated mode are stored (except with temporary memory modes, described below), while operation shifts from vfo to a memory channel, or vice-versa. The vfo or memory channel recalled is always the one that was last used. (When a memory channel is selected, 'MR' appears to the left of the displayed frequency, and 'CH' appears to the right, with the channel number beneath it.)

Split Frequency Operation

The two vfos and the SPLIT key can be used for split frequency operation as follows:

- (1) Press VFO A/B, if necessary, to select VFO B (displayed at the left).
- (2) Tune to the desired transmit frequency (and mode).
- (3) Press VFO A/B to select VFO A, and tune to the desired receive frequency & mode.

- (4) Press SPLIT.

Now receiving is on VFO A, but when the PTT switch or key is closed, transmission is on VFO B. To reverse transmit and receive frequencies (for example, to listen on the transmit frequency), just press VFO A/B.

An alternative method to operate split is to use one vfo and the clarifier, mentioned previously in the SSB Transmission section. Tune the vfo to the transmit frequency, then press CLAR and tune to the receive frequency (and other mode, if required).

To listen on the transmit frequency, press CLAR again, and then once more to return to the receive frequency (which is stored in a 'clarifier memory'). Note, however, that the clarifier memory is lost if the tuning knob moves while checking the transmit frequency.

Memory Storage

This procedure allows storage of the vfo mode and frequency into a memory channel;

- (1) Set the VFO to the frequency and mode of emission to be stored.
- (2) While receiving, press MR/VFO to switch from vfo to memories.
- (3) Press the DWN/UP keys, if necessary, to select an unused memory channel (default data is 7.000 MHz LSB in all channels).
- (4) Press MR/VFO again to return to the vfo.
- (5) Press VFO►M (lower center) to write the data from the vfo to the memory.

Note that the VFO►MR key overwrites (erases!) the previous memory contents. Steps (2), (3) and (4) are required only to select the memory channel that is to be written. If you already know that the last-selected memory is free to accept new data, these steps can be skipped.

Memory Recall

- (1) Press MR/VFO to recall memories: the display and mode indicators will change to the last memory channel accessed.
- (2) While watching the displayed channel number press the DWN and UP keys to select different memory channels.

The mode of emission of a recalled memory channel may be changed temporarily by the MODE keys. When another memory or vfo is selected, the temporary mode selection is cancelled. Changing the frequency or the stored mode of the memory requires restoring from a vfo.

Changing Memory Mode & Frequency

To change the data stored in a memory channel it is necessary to shift the data to a vfo where it can be manipulated.

- (1) Press MR/VFO and the DWN/UP keys to select the memory to be changed.
- (2) Press MR/VFO again to return to the vfo (either A or B: data will not be lost).
- (3) Press VFO \blacktriangle M to exchange the vfo and memory contents.
- (4) Now retune or change mode as desired.
- (5) Press VFO \blacktriangle M to exchange the vfo and memory again, restoring the new data from the vfo to memory, and original vfo data back from the memory to the vfo.

If operating on a memory and you don't care to preserve the vfo data, you can just press M \blacktriangleright VFO to copy the memory channel data to the last selected vfo. This leaves the memory data intact, but overwrites all data in the vfo and leaves operation on the vfo.

SCANNING

When the squelch control is adjusted to silence the receiver, either the memories or a preselected frequency segment may be scanned automatically. Signals that are strong enough to open the squelch will halt the scanner. Note that the RF AMP and ATT switches and the RF (gain) control must

be set for the desired sensitivity before adjusting the SQL control, as these will affect the squelch sensitivity.

The SCAN MODE switch activates the scanning modes, during which the VFO A/B and MR/VFO keys adopt alternate functions, as explained below.

Memory Channel Scanning

To scan the 10 memory channels:

- (1) Preset the SQL control to the point where background noise is just silenced.
- (2) Press MR/VFO to recall the memories.
- (3) Press SCAN MODE, and MR/VFO again to start the scanner.

Scanning will pause on any channel having a signal strong enough to open the squelch, and will resume again if the signal drops out. While paused, if you press MR/VFO a double beep will sound and operation will shift to the next higher-numbered channel.

To stop the scanner manually press MR/VFO or the PTT switch momentarily. Return the SCAN MODE switch to the off (out) position to return the vfo/memory keys to their standard functions.

Scanning Between Vfos

If you set up the vfos as scanning limits, you can scan all frequencies in between by pressing SCAN MODE and then VFO A/B while operating on a vfo. Press FAST to select high-speed scanning.

Scanning will pause on a signal and resume if the signal drops out (or manually, by turning the SQL clockwise). Pressing VFO A/B while paused moves the frequency one step.

To manually stop scanning and set the selected vfo to the displayed frequency, press VFO A/B or the PTT switch momentarily. To cancel scanning altogether, return SCAN MODE to the out (off) position.

Programmable Memory Scanning (PMS)

The PMS feature allows you to scan all frequencies between those stored in any two adjacent memory channels. The starting frequency and mode of the scanner are determined by the selected memory

channel. Slow and fast (x10) rates are selectable as for vfo scanning. Which ever vfo was last selected prior to activating PMS will be changed by PMS scanning.

To use programmable memory scanning:

- (1) Store the lower and upper scanning limits in adjacent memories, and select the one you want to start at.
- (2) Preset the SQL control to the point where background noise is just silenced.
- (3) Press SCAN MODE on, and then press the DWN key to scan to the next lower

numbered memory, or UP key to scan to the next higher-numbered memory. 'P' will be displayed in place of the memory channel number, indicating that the PMS system is now activated.

PMS scanning will pause automatically when the squelch opens, or can be manually halted by the PTT switch or DWN/UP keys: the PMS function remains active ('P' still displayed). Press DWN or UP again to resume scanning.

When the SCAN MODE switch is returned to off (out), PMS scanning is cancelled and normal operation resumes on the last-selected vfo, which will be set to the frequency and mode last tuned during scanning.

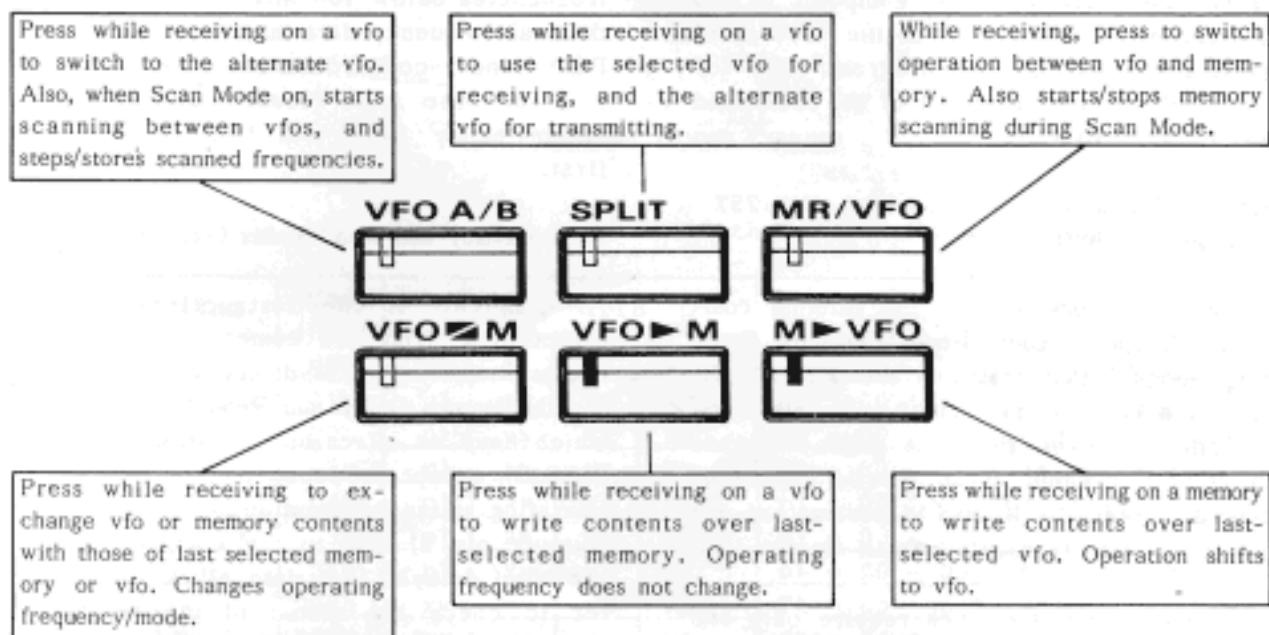

CAT SYSTEM COMPUTER CONTROL

The CAT (Computer-Aided Tuning) System in the FT-757GXII allows control of the frequency and mode of vfos and memories, selection between them, and signal strength detection and scanning control by the operator's external personal computer. Uni- or bi-directional serial data is passed via the CAT jack on the rear panel of the transceiver, as follows:

DATA RATE: 4800 bits/sec
 START BIT: 1
 DATA BITS: 8
 STOP BITS: 2
 PARITY: none

The chart at the bottom of this page shows the entire data sequence for one CAT command. Data is transmitted from the computer to the SI (Serial Input) pin (pin 3 of the CAT jack) from left to right in the diagram. So, for example, Parameter (Parm) 4 of the Command Block is sent first.

Note: All data blocks sent to the 757 must be five bytes long.

The Instruction Code sent by the external computer at the end of each 5-byte Command Block is the 'opcode' that instructs the FT-757GXII what action is to be performed. The Instruction Code Chart on the next page describes each valid Command. If an invalid (unlisted) command is sent, or if invalid parameters are recognized, the transceiver will ignore the command.

Notice that most Instructions require only one or no arguments in the Parameter Bytes. However, every Command Block sent to the FT-757GXII must always consist of five bytes. The unused parameter bytes will be ignored when such Instructions are executed, so their value is irrelevant (they need not be zeroed).

EXAMPLE: to set 14.25000 MHz as the current operating frequency;

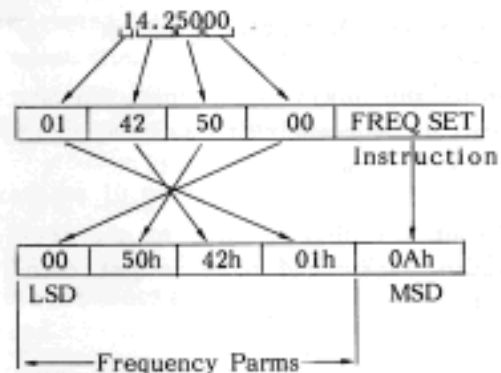

Notice that, for frequency parameters, the 100 MHz digit must be present and set to zero for frequencies below 100 MHz. Also notice that decimal frequency data must be translated into BCD (binary-coded decimal) digits for sending, and that the LSD (least significant digit, Parameter 4, 100's and 10's of Hz) is sent first.

Return Delay and Read Status Commands

All but two of the Instructions are uni-directional; from the computer to the transceiver only. The bi-directional instructions are the Return Delay and Read Status commands, which have no effect on operation of the FT-757GXII except to cause it to return current operating status information on the SO (Serial Output, pin 2) line to the computer (after a specified delay). This data allows the computer to check the status of the transceiver, and so the program should send one of these commands to verify the transceiver state after each series of instructions. Also, the Read Status command is sent with a 01 parameter to read the digitized signal strength indication (0 to 0Fh).

CAT SYSTEM TIMING CHART

| | | | | | | | | | | |
|-----------|-----------|----|----|----|----|----|----|----|----|---------------|
| Data Byte | START BIT | D0 | D1 | D2 | D3 | D4 | D5 | D6 | D7 | STOP BITS (2) |
|-----------|-----------|----|----|----|----|----|----|----|----|---------------|

| | | | | | |
|----------------------|--------------|--------|--------|--------|------------------------|
| 5-byte Command Block | Parm 4 (LSD) | Parm 3 | Parm 2 | Parm 1 | Instruction Code (MSD) |
|----------------------|--------------|--------|--------|--------|------------------------|

*100ms MAX

After the Return Delay or Read Status command has been sent, the transceiver will wait for 0 to 255 ms, as set by Parameter 1 of the Return Delay command, to allow enough time for the computer program to get set to receive the status data. The transceiver then returns either one byte (if Parameter 1 is set to 1 in the Read Status command, for the S-meter indication), or 75 bytes (for complete status information on the vfos and all memories). In the latter case, each of the 75 bytes is separated by the delay set by the last time the Return Delay command was sent. Note that 75 bytes are always returned after the Return Delay command, as well as after the Read Stat-

us command (with Parameter 1 = 0).

The Status Update Chart and accompanying tables show the format of the 75 bytes returned after the Return Delay command, or when the Read Status command is sent with a 0 parameter: notice that some flags are carried in bit fields in the first status byte.

The CAT jack also provides access to the PTT (Push-To-Talk) line at pin 4 to allow keying the transmitter. This pin has 8V DC on it when open-circuit (during reception), and activates the transmitter when grounded (sourcing 8 mA).

INSTRUCTION CODE CHART

NOTE: Commands are sent in the REVERSE of the order shown in this Chart.

| Instruction Name | Code (Hex) MSD | Parameters | | | | Remarks |
|------------------|----------------|------------|----|----|-------|--|
| | | 1 | 2 | 3 | 4 LSD | |
| SPLIT | 01h | p1 | xx | xx | xx | p1 = 00 (OFF) or 01 (ON) |
| MR | 02h | p1 | xx | xx | xx | p1 = 00 - 09 (Channel No) |
| M | 03h | p1 | xx | xx | xx | p1 = 00 - 09 (Channel No) |
| D LOCK | 04h | p1 | xx | xx | xx | p1 = 00 (OFF) or 01 (ON) |
| VFO A/B | 05h | p1 | xx | xx | xx | p1 = 00 (A) or 01 (B) |
| M - VFO | 06h | p1 | xx | xx | xx | p1 = 00 - 09 (Channel No) |
| BAND UP | 07h | xx | xx | xx | xx | Step up one Band* |
| BAND DWN | 08h | xx | xx | xx | xx | Step down one Band* |
| CLARIFIER | 09h | p1 | xx | xx | xx | p1 = 00 (OFF) or 01 (ON) |
| FREQ SET*** | 0Ah | p1 | p2 | p3 | p4 | Frequency Set (see EXMPL) |
| SWAP | 0Bh | xx | xx | xx | xx | Swap VFO and Memory |
| MODESEL | 0Ch | p1 | xx | xx | xx | p1 value: 00=LSB, 01=USB 02=CWW, 03=CWN, 04=AM, 05=FM |
| HGSEL | 0Dh | p1 | xx | xx | xx | p1 = 00 (GEN) or 01 (HAM) |
| RETURN DELAY | 0Eh | p1 | xx | xx | xx | p1 = 00 to FFh ms delay** |
| READ STATUS | 10h | p1 | xx | xx | xx | p1 = 00, or 01 (Meter-only) |

xx = any value: byte will not affect command function.

* Band steps determined by current Ham/Gen selection: Ham bands, or 0.5 MHz.

** Delay between response bytes from transceiver after receipt of RETURN DELAY or READ STATUS command.

*** This command only functions when operating on a vfo (test Status Update Byte 1, Bit 3 (MR/vfo flag)). Parameters must be in BCD format.

STATUS UPDATE CHART

(format of data returned by 757GXII after RETURN DELAY command, or READ STATUS command with 0 parm)

| Byte No. | Contents | Ref. Table |
|----------|---------------------------------------|------------|
| 1 | Status Flags | 1 |
| 2 | SCAN MODE* (00=OFF, 80h=ON) | |
| 3 | not used | |
| 4 | Band Data | 2 |
| 5 | Selected Memory Channel No. (0-9) | |
| 6-9 | Operating Frequency (BCD) | 3 |
| 10 | Selected Mode** | |
| 11-14 | VFO A Frequency (BCD) | 3 |
| 15 | VFO A Mode** | |
| 16-19 | VFO B Frequency (BCD) | 3 |
| 20 | VFO B Mode** | |
| 21-24 | Clarifier Frequency (BCD) | 3 |
| 25 | Clarifier Mode** | |
| 26-29 | Memory Channel 0 Frequency (BCD) | 3 |
| 30 | Memory Channel 0 Mode** | |
| 31-35 | Memory Ch 1 (same format as 26-30)*** | |
| 36-40 | Memory Ch 2 (same format as 26-30)*** | |
| 41-45 | Memory Ch 3 (same format as 26-30)*** | |
| 46-50 | Memory Ch 4 (same format as 26-30)*** | |
| 51-55 | Memory Ch 5 (same format as 26-30)*** | |
| 56-60 | Memory Ch 6 (same format as 26-30)*** | |
| 61-65 | Memory Ch 7 (same format as 26-30)*** | |
| 66-70 | Memory Ch 8 (same format as 26-30)*** | |
| 71-75 | Memory Ch 9 (same format as 26-30)*** | |

* Indicates position of front panel switch with the same name.

** Byte values are those indicated for Modes in the Instruction Code Chart.

*** Calculate Memory Channel addresses by:
 Channel Freq Index = (Ch No. x 5) + 26
 Channel Mode Index = (Ch No. x 5) + 30

TABLE 2. BAND DATA

| Byte Value | Frequency Range (MHz) |
|------------|-----------------------|
| 01 | below 2.5 |
| 02 | 2.5 - 4.0* |
| 03 | 4.0 - 7.5 |
| 04 | 7.5 - 10.5 |
| 05 | 10.5 - 14.5 |
| 06 | 14.5 - 18.5 |
| 07 | 18.5 - 21.5 |
| 08 | 21.5 - 25.0 |
| 09 | 25.0 - 30.0 |

* high end of each band range is actually 10 Hz below the freq shown.

TABLE 1. STATUS FLAG BITS

| Bit | Function | 0 = OFF (unlkd) | 1 = ON (locked) |
|----------------|------------|-----------------|----------------------|
| 2 ⁷ | Dial Lock: | 0 = OFF (unlkd) | 1 = ON (locked) |
| 2 ⁶ | Split: | 0 = OFF (Smplx) | 1 = ON (Split tx/rx) |
| 2 ⁵ | Clarifier: | 0 = OFF, | 1 = ON |
| 2 ⁴ | A/B vfo: | 0 = A selected, | 1 = vfo B selected |
| 2 ³ | Mem/vfo: | 0 = vfo opratn, | 1 = memory operation |
| 2 ² | Tx/Rx: | 0 = receiving, | 1 = transmitting |
| 2 ¹ | Gen/Ham: | 0 = Gen Steps, | 1 = Ham Band Steps |
| 2 ⁰ | not used | | |

TABLE 3. FREQUENCY DATA

Frequency digits appear in the data stream as binary-coded decimal (BCD: hexadecimal representation of decimal digits), with leading zero-fill to the 100's of MHz digit. Bytes are sent in reverse order, as described earlier and again in the following example.

(EXAMPLE) 012.34567 MHz:

- (Freq. Index + 3) = 01h
- (Freq. Index + 2) = 23h
- (Freq. Index + 1) = 45h
- (Freq. Index + 0) = 67h

TEST PROGRAM LISTING

Following is a listing of a BASIC program developed on an Apple II computer using a Yaesu FIF-65A CAT Interface Unit, which tests a number of the CAT System functions in the FT-757GXII. The program has been intentionally simplified so that it might easily be converted for use on other computers with other serial i/o systems and with other variations of BASIC. As such, it is not useful as an application program by itself, but rather is intended to provide some ideas for a simple approach to CAT programming, which should be combined with the users own concepts for useful applications.

This program is not copyrighted. Anyone is free to use any part of the code for their own use. For use in commercial applications, acknowledgement of this manual as the source would be appreciated.

```

1  REM *****
3  REM * FT-757GXII CAT SYSTEM TEST *
5  REM *****

10 REM ***** Initialize Serial I/O Port of computer *****
20 IOPORT = 49344 : REM Serial Data Port Address (particular to FIF-65/A)
30 CMDPORT = IOPORT + 1 : REM Serial Command Port Address
40 FOR I = 1 TO 3 : POKE CMDPORT,0 : NEXT I : REM Clear IO chip (8251 USART in FIF-65/A) for init.
50 POKE CMDPORT,64 : POKE CMDPORT,207 : POKE CMDPORT,55 : REM Init USART for 4800 baud, no parity, 1 stop bit.
60 HOME : PRINT : REM Clear the screen

100 REM ***** Display Menu of User Commands *****
110 PRINT : PRINT "(0)...Enter Frequency"
120 PRINT "(1)...lsb "
130 PRINT "(2)...usb "
140 PRINT "(3)...cw-w"
150 PRINT "(4)...cw-n"
160 PRINT "(5)...am "
170 PRINT "(6)...fm "
180 PRINT "(7)...vfo-A"
190 PRINT "(8)...vfo-B"
200 PRINT "(9)...Read Stats"
210 INPUT "Select a number" ; CMND : REM Get command from keyboard
220 IF CMND <> 0 THEN 600 : REM Jump around for all except freq. entry

300 REM ***** Get new Frequency, test for valid range, and retry if invalid *****
310 INPUT "Input new Freq. (decimal MHz)" ; FREQ
320 IF FREQ < 0.150 OR FREQ > 29.99999 THEN PRINT "Out of Range. Re-enter Freq." : GOTO 310

400 REM ***** Split FREQ into pairs of decimal digits *****
410 FREQ = FREQ * 10000 : REM Convert to Integer (10's of kHz)
420 MHz = INT (FREQ / 100000) : REM 100's and 10's of MHz
430 MkHz = INT (FREQ / 1000) - MHz * 100 : REM 1's of MHz and 100's of kHz
440 kHz = INT (FREQ / 10) - MHz*10000 - MkHz*100 : REM 10's and 1's of kHz
450 LMHz = MHz * 100000 : LMHz = MkHz * 1000 : LkHz = kHz * 10 : REM Convert back to long value
460 Hz = FREQ - LMHz - LMHz - LkHz : REM Subtract larger digits., leave 100's & 10's of Hz.
470 Hz = INT (Hz + 0.5) * 10 : REM Round it up

480 REM ***** Convert Decimal digit pairs into BCD Parameters *****
490 P1 = INT (MHz / 10) * 16 + MkHz - INT (MkHz / 10) * 10
500 P2 = INT (MkHz / 10) * 16 + kHz - INT (kHz / 10) * 10
510 P3 = INT (kHz / 10) * 16 + Hz - INT (Hz / 10) * 10
520 P4 = INT (Hz / 10) * 16 + Hz - INT (Hz / 10) * 10
530 INST = 10 : GOSUB 1000 : GOTO 100 : REM Instruction = Set Freq., Send to xcvr, and loop.

600 REM ***** Set Instruction and Parameter for other commands *****
610 IF CMND = 1 THEN INST = 12 : P1 = 0 : REM Instruction = Set Mode, P1 = lsb
620 IF CMND = 2 THEN INST = 12 : P1 = 1 : REM Instruction = Set Mode, P1 = usb
630 IF CMND = 3 THEN INST = 12 : P1 = 2 : REM Instruction = Set Mode, P1 = cw-w
640 IF CMND = 4 THEN INST = 12 : P1 = 3 : REM Instruction = Set Mode, P1 = cw-n
650 IF CMND = 5 THEN INST = 12 : P1 = 4 : REM Instruction = Set Mode, P1 = am
660 IF CMND = 6 THEN INST = 12 : P1 = 5 : REM Instruction = Set Mode, P1 = fm
670 IF CMND = 7 THEN INST = 5 : P1 = 0 : REM Instruction = Set vfo A/B, P1 = vfo-A
680 IF CMND = 8 THEN INST = 5 : P1 = 1 : REM Instruction = Set vfo A/B, P1 = vfo-B
690 IF CMND = 9 THEN GOTO 800 : REM Get Update Status
700 GOSUB 1000 : GOTO 100 : REM Send 5 bytes to xcvr, and loop back to menu

800 REM ***** Select data to read from Transceiver *****
810 INPUT "Hit 0 for all Stats, or 1 for S-meter" ; TYPE : REM Determine type of data to read
820 IF TYPE <> 0 THEN 900 : REM Jump for S-meter data

```



```

830 REM ***** Send "Return Delay" Command - returns 75-byte Status Update *****
840 INST = 14 : P1 = 100 : GOSUB 1000 : REM Set resp. delay to 100ms, get Status Update

850 REM ***** Read 75 bytes as they come back from Transceiver *****
860 FOR I = 0 TO 75 : REM Set Retry counter
870 GOSUB 2000 : REM Check serial port input status
880 PRINT "Status Byte #"; I ; " = " ; PEEK (IOPORT) : REM Print status byte read
890 NEXT I : GOTO 100 : REM Read another byte, return to menu if done

900 REM ***** Send "Read Status" Command, and read 1-byte S-meter data *****
910 INST = 16 : P1 = 1 : GOSUB 1000 : REM Inst = Read Status, P1 = S-meter. Send it.
920 GOSUB 2000 : REM Check serial port input status
930 PRINT "Signal Strength is " ; PEEK (IOPORT) : REM 0 to 15
940 GOTO 100 : REM Return to menu

1000 REM ***** Send 5 bytes to Transceiver *****
1010 POKE IOPORT,P4 : POKE IOPORT,P3 : POKE IOPORT,P2 : POKE IOPORT,P1 : POKE IOPORT,INST
1020 RETURN

2000 REM ***** Check serial port input status *****
2010 IOSTAT = PEEK (CMDPORT) : REM Get USART Status
2020 RXRDY = INT (IOSTAT / 2) : REM Rotate RxDy flag (bit 1) to bit 0
2030 RSTAT1 = INT (RXRDY / 2) : RSTAT2 = RXRDY / 2 : REM Check if Odd (set) or Even (reset)
2040 IF RSTAT1 = RSTAT2 THEN 2010 : REM Loop until it is set
2050 RETURN

```

RECEIVER FRONT END PROTECTION

The receiver front end in FT-757GXII includes a vacuum arc surge suppressor and a lamp fuse to protect the sensitive receiver circuitry from high voltage pulses (EMP) at the antenna terminal. Several thousands of volts can develop naturally when dry wind or electrical storms create an electrostatic charge on the antenna elements, and this is delivered to the antenna jack if the antenna is connected to the transceiver. In such a case, the lamp fuse may burn out (even if the transceiver is turned off at the time). The only way to avoid this condition is to disconnect the antenna from the transceiver whenever the weather is likely to create high voltage on the antenna (the feedline should be connected to ground to allow the charge to dissipate).

If the receiver is found to have suddenly lost sensitivity, inspect the filament of the lamp fuse (F1001 on the RF Unit). If it is open, try to determine the cause of the overvoltage; eg., was the antenna left connected during an electrical storm or dry windy weather since you last used the equipment? To obtain replacement lamp fuses, ask your local Yaesu dealer for Yaesu part no. Q1000010, BQ041-22803A; or substitute any 8V 100mA pilot lamp. Do not jumper across the lamp fuse terminals however, as this will defeat the protection and could result in serious damage.

See picture below for the location of the lamp fuse.

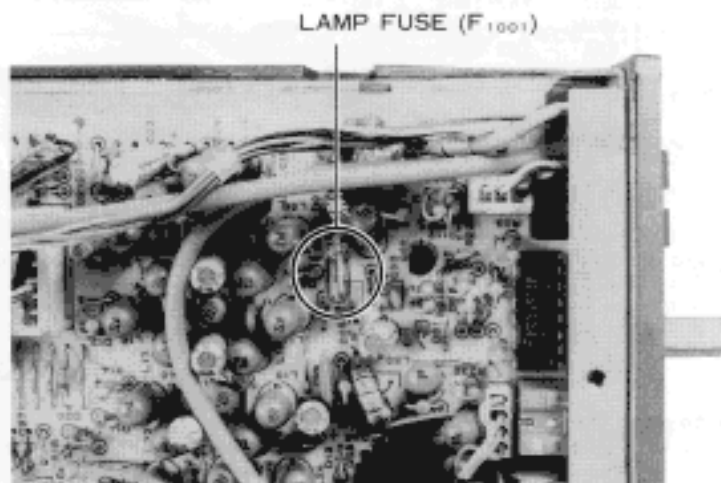

NOTES :

FT 757GX II

MANUAL MODE

COMPUTER AIDED TRANSFER

